

Haier



Deep Freezer Operation Manual

Certificate of Quality

checker:

Manufacturer: Qingdao Haier Biomedical Co., Ltd.
Address: Haier Industrial Park, Economic Technology Development
Zone, Qingdao P.R. China
Web: www.haiermedical.com
Revision Date: 02/2020
Version: 1st, 2020
Dedicated code: 0270501299WD
V13026



Model
DW-60W138
DW-60W258
DW-60W388
DW-40W100J
DW-40W255J
DW-40W380J

- Read the Operation Manual carefully before using your appliance.
- Keep the Operation Manual in a safe place.
- Appearance, color and layout of the door may vary.
- Translation of the original instruction.
- The product is fit for low temperature storing goods.
- This product is for commercial use only.









Content

| | |
|--|----|
| Safety Precautions | 1 |
| Application guidelines..... | 4 |
| Product Feature..... | 5 |
| Product installation | 6 |
| Name of parts | 10 |
| Application method..... | 11 |
| Alarm | 14 |
| Cleaning maintenance..... | 15 |
| FAQ | 16 |
| Refrigeration Schematic & Circuit Diagram..... | 18 |
| Circuit Diagram..... | 20 |
| Specification | 21 |



Safety Precautions







Dear Customers,
Thank you for choosing Haier deep freezer. Please make sure that you have carefully read the manual and follow the instruction as outlined. This is to prevent personal injury and damage to products.

Safety labels

| | | |
|--|--|---|
|  The upper and lower limits of temperature shall be indicated adjacent to the upper and lower horizontal lines. |  Symbol for "Manufacture" |  WARNING! ELECTRIC CABINET CONTAINS CONTROL PANEL CONTACTOR ETC. |
|  Symbol for "Consult instructions for use" |  Symbol for "Date of manufacture" | |
|  EC REP European Authorized Representative | Elcolab BV. Tolboomweg 10, 3784 XC Terschuur, the Netherlands | |
|  R600a/R1150/R290 | |  Grounding mark |
| NOTICE! 1.Freezer must be placed at least 20mm away from the wall to allow maximum air circulation. 2.Changing of refrigerants should be done according to the Service Manual. | |  0197 Complied with the requirements of MDD 93/42/EEC annex V |

Safety precautions

| | | |
|--|--|--|
|  Warning | Ignoring this warning may result in death or serious injury |  Actions or operations which are prohibited |
|  Caution | Ignoring this warning may result in death or serious injury, and/or damage to the freezer and property | |

-  When there is a leak of flammable gas, shut off the feed valve of the gas. Open windows for ventilation and exhaust. Do not plug in your freezer or unplug your freezer as spark in these processes can cause an explosion or fire.
-  We recommend the unit be installed and maintained by the professional to avoid any electrical hazard.
-  Place the freezer on solid and flat ground to avoid tipping the unit over to cause personal injury.
-  Only connect the freezer unit with a dedicated power outlet specified by the nameplate of the unit. This is to avoid fire or electric shock.
-  If the supply voltage is lower or higher than the rated voltage, an automatic voltage regulator of at least 4,000W should be installed with the refrigerator.
-  If the power cord needs to be lengthened, the cross section area of the extension line's conductor should be at least 2 mm² and the length of the extension cord should be limited to 3m. This is to prevent electric fire or shock.

- ❗ The power cord of this freezer is provided with a three-wire (earthing) plug, complying with the standard 16A three-wire (earthing) socket. Never cut or remove the earthing pin of the power cord in any case. Make sure that the power plug and socket is inserted tightly and reliably, otherwise it may result in a fire.
- ❗ Please use an earthed power supply socket for fear of electric shock. If the power socket is not earthed, be sure to have the earth wire installed by a professional technician.
- ⊘ Do not use the freezer in the open air. When the freezer gets wet in the rainwater, it may cause leakage of electricity or electric shock.
- ⊘ Do not place the freezer in a damp site or a place where it may easily suffer from spraying water. Otherwise, it may cause leakage of electricity or electric shock due to degeneration of its insulation.
- ⊘ Do not pour water onto the freezer in a direct inclined way, otherwise it may cause an electric shock or a short circuit.
- ⊘ Do not place any vessel containing water or any heavy object on the freezer. If the object drops off, it may cause personal injury and the flowing water will degenerate the insulation and further cause leakage of electricity or electric shock.
- ⊘ Do not make the freezer earthed via a gas-pipe, power supply conduit, telephone line or lightning rod. The above earthing will cause an electric shock or other dangers.
- ⊘ Do not contact any electric parts or any switches such as power plug and so forth with a wet hand, or otherwise it may cause an electric shock.
- ❗ When pulling out a plug from the power socket, hold the power plug firmly but do not pull the wire of the power plug. Pulling the wire with hand may cause an electric shock or lead to a fire due to short circuit.
- ❗ If the freezer runs out of order, please pull out the power plug. Continuous running in an abnormal condition may cause an electric shock or fire.
- ❗ User must not dismantle, repair or refit the freezer by itself. Otherwise, it may cause a fire or personal injury due to improper operation.
- ❗ Before conducting any repair or maintenance of the freezer, be sure to disconnect the power of the freezer for fear of electric shock or personal injury .
- ❗ Pull out the power plug when the freezer is not in service for a long time so as to prevent electric shock, leakage of electricity or fire due to aging of the power cord.
- ❗ If the freezer is left unused for a long time in an unattended area, make sure that children will not approach the freezer and the freezer door will not be closed completely.
- ❗ Disposal of discarded freezer shall be conducted by the relevant personnel. Dismantle the door to prevent occurrence of accidents such as suffocation.
- ⊘ Do not set off hazardous articles that are inflammable, explosive or volatilizable in the freezer, nor use the flammable spraying agent in the vicinity of the freezer, or otherwise, it may trigger an explosion or fire.
- ⊘ Do not store corrosive articles such as acid, alkali etc. in the freezer. Otherwise, it may spoil the internal units or electric parts of the freezer.

Packing List

| Name | DW-60W138 | DW-60W258 | DW-60W388 |
|----------------|------------|------------|------------|
| Manual | 1 | 1 | 1 |
| Plastic bag | 1 | 1 | 1 |
| Key | 2 | 2 | 2 |
| Ice scraper | 1 | 1 | 1 |
| Name | DW-40W100J | DW-40W255J | DW-40W380J |
| Manual | 1 | 1 | 1 |
| Plastic bag | 1 | 1 | 1 |
| Key | 2 | 2 | 2 |
| Ice scraper | 1 | 1 | 1 |
| Storage basket | 1 | 2 | 6 |

Global Warming Potential

| Model | Rated voltage(VAC) | Rated frequency (Hz) | CO ₂ equivalent(Tonnes) |
|------------|--------------------|----------------------|------------------------------------|
| DW-60W138 | 220-240~ | 50 | 2.3 |
| DW-60W258 | 220-240~ | 50 | 2.6 |
| DW-60W388 | 220-240~ | 50 | 2.8 |
| DW-40W100J | 220-240~ | 50 | 0.9 |
| DW-40W255J | 220-240~ | 50 | 1.1 |
| DW-40W380J | 220-240~ | 50 | 1.3 |

This product contains fluorinated greenhouse gases covered by the Kyoto Protocol. Do not vent into the atmosphere.

GWP=global warming potential

| Refrigerant type | GWP |
|------------------|-----|
| R600a | 20 |
| R1150 | 20 |
| R290 | 20 |

| | | | |
|---|--|--------------|--------------|
| Name | Deep Freezer | | |
| Model | DW-40W100J | DW-40W255J | DW-40W380J |
| Exterior dimensions (W × D × H) (mm) | 790×770×950 | 1210×770×950 | 1655×770×950 |
| Interior dimensions (W × D × H) (mm) | 580×445×620 | 1000×445×620 | 1450×445×620 |
| Effective volume(L) | 100 | 255 | 380 |
| Door | Foaming door | | |
| Insulation | CFC-Free foamed-in-place urethane | | |
| Compressor | High Quality Hermetically sealed compressor | | |
| Basket / loading of each | 1 / max:10kg | 2 / max:10kg | 6 / max:10kg |
| Refrigeration | Direct cooling | | |
| Exterior / Interior | Spraying steel plate / Stainless steel | | |
| Condenser/Evaporator | Wire and tube type / coil tube type | | |
| Temperature control | Microprocessor controlled | | |
| Refrigerant | R290 45g | R290 55g | R290 65g |
| Weight(kg) | 52 | 76 | 90 |
| Temperature range | -20℃ ~-40℃ | | |
| Voltage | 220-240V~/50Hz | | |
| Rated power/current(W) | 260 | 370 | 450 |
| Noise Level(dB(A)) | 42 | 42 | 42 |
| Foaming Agent | HFO-1233zde | | |
| Climate Type | 4 | | |
| Type of protection against electric shock | I | | |
| Test hole | 1 | | |
| Alarms | Overtemperature alarm, sensor error alarm, power failure alarm | | |
| Duration time of power outage alarm | 24 hours (when battery is fully charged) | | |

Note: Climate Type 4 means the temperature is +30℃, the relative humidity is 55%. Technical information may vary from the appliance that you have just purchased due to technical improvements.

- ⊘ Do not place the packing plastic bags at the locations where children can easily take as plastic bags may cause occurrence of suffocation accident.
- ⊘ Do not climb up to the freezer or place articles on the freezer, otherwise it may cause personal injury or damage of freezer due to overturn of the freezer.
- ⊘ Do not insert any metal objects like iron nails, iron-wire into any orifice and gap or any air vent used for internal air circulation of the freezer, otherwise, it may cause an electric shock or injury due to contact of the above objects with the moving parts.
- ⚠ When restarting the freezer after a power failure or power-off, it is required to check the setting of the freezer. Change of setting may spoil the articles stored.
- ⚠ Once the power of the freezer is cut off, wait for over 5 minutes before it is reconnected so as not to damage the compressor or the system.
- ⚠ Put on your gloves at time of maintenance so as not to bump the sharp edges or corners, resulting in personal injury.
- ⚠ Close the door of the freezer with your hand holding the handle so that your fingers will not be pinched by the door.
- ⚠ The inclination angle shall be no greater than 45 ° when handling the freezer.
- ⚠ When handling the freezer, be careful not to trip over it, preventing personal injury or damage to the freezer.
- ⊘ Do not pull or carry the equipment by the door handle, preventing damage to the freezer or personal injury.
- ⚠ There shall be no obstacles around the freezer, and keep it well-ventilated and clear.
- ⊘ Do not spoil the refrigerating circuit.
- ⊘ Do not use any electric appliance in the store-room of the freezer except for the types that the manufacturer recommended for use.

Application guidelines

During the normal process of use, please read the following precautions seriously before use, in order to keep the low-temperature freezer in the best performance:

- Storage and withdrawal of stored articles
 - a. Before putting any article in the freezer, you should confirm that whether the storage temperature of article complies with the setting temperature of the freezer in advance;
 - b. Before putting any article in the freezer, you should confirm that whether the temperature within the freezer has already reached to the setting temperature in advance;
 - c. When putting in the articles, you should put them successively in batches, and the volume of article to be put each time could not be larger than 1/3 of volume of the freezer, in order not to make the refrigerating system overloaded;
 - d. When putting or taking the articles each time, please minimize the time for door closing, in order to reduce the energy consumption and keep the temperature within the freezer relatively stable;



Meaning of crossed –out wheeled dustbin:

Do not dispose of electrical appliances as unsorted municipal waste, use separate collection facilities. Contact you local government for information regarding the collection systems available. If electrical appliances are disposed of in landfills or dumps, hazardous substances can leak into the groundwater and get into the food chain, damaging your health and well-being.

Specification

Specification

| Name | Deep Freezer | | |
|---|---|------------------------|------------------------|
| Model | DW-60W138 | DW-60W258 | DW-60W388 |
| Exterior dimensions (W × D × H) (mm) | 790×770×950 | 1210×770×950 | 1655×770×950 |
| Interior dimensions (W × D × H) (mm) | 580×445×620 | 1000×445×620 | 1450×445×620 |
| Effective volume(L) | 138 | 258 | 388 |
| Door | Foaming door | | |
| Insulation | CFC-Free foamed-in-place urethane | | |
| Compressor | High Quality Hermetically sealed compressor | | |
| Basket / loading of each | 1 / max:10kg | 1 / max:10kg | 1 / max:10kg |
| Refrigeration | Direct cooling | | |
| Exterior / Interior | Spraying steel plate / Stainless steel | | |
| Condenser/Evaporator | Wire and tube type / coil tube type | | |
| Temperature control | Microprocessor controlled | | |
| Refrigerant | R600a 85g R1150 30g | R600a 90g R1150 40g | R600a 95g R1150 45g |
| Weight(kg) | 62 | 88 | 105 |
| Temperature range | -30℃ ~-60℃ | -30℃ ~-60℃ | -30℃ ~-60℃ |
| Voltage | 220-240V~/50Hz | 220-240V~/50Hz | 220-240V~/50Hz |
| Rated power/current(W) | 620 | 620 | 700 |
| Noise Level(dB(A)) | 43 | 43 | 43 |
| Foaming Agent | HFO-1233zde | | |
| Climate Type | 4 | | |
| Type of protection against electric shock | I | | |
| Test hole | 1 | | |
| Alarms | Overtemperature alarm, sensor error alarm | | |

Note: Climate Type 4 means the temperature is +30℃ ,the relative humidity is 55%. Technical information may vary from the appliance that you have just purchased due to technical improvements.

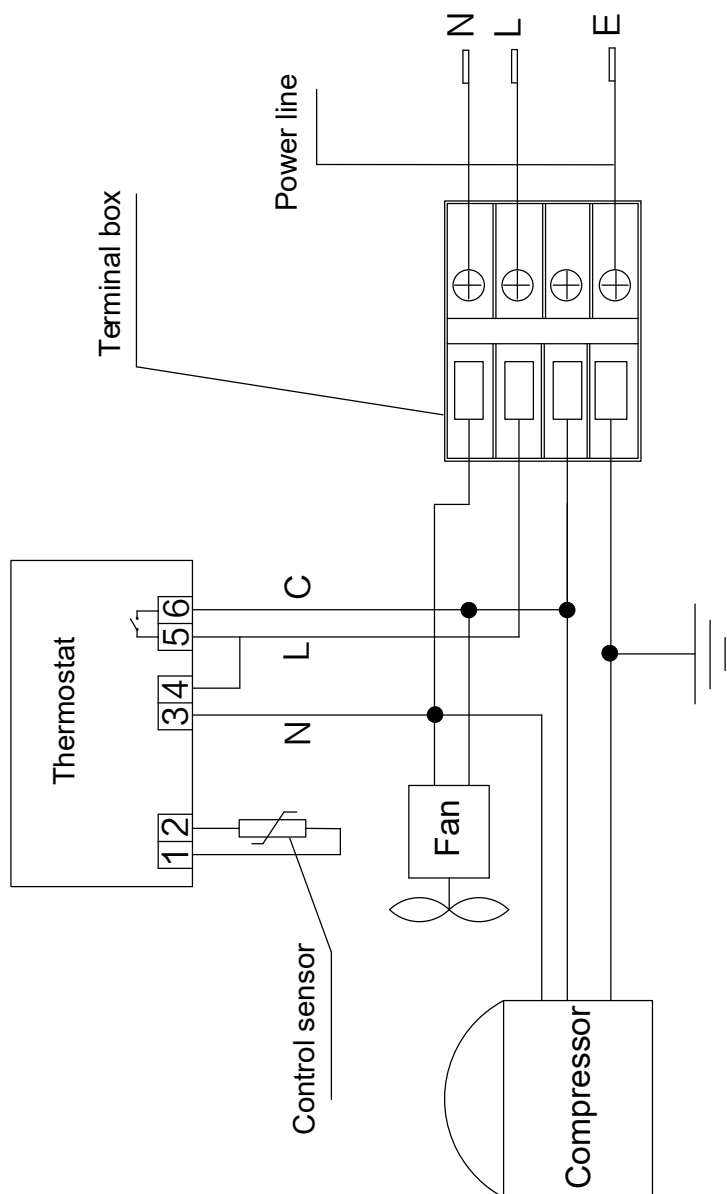

Product Feature

This product is used to store high level ingredients such as tuna, Australian lobster, salmon, South American shrimp, Argentine red shrimp, and top beef. Applicable to professional sea fishing enthusiasts, major fishing wholesalers, precious seafood ingredients franchise stores, restaurants and so on.

1. Temperature control

Inner temperature:

DW-60W138/258/388 -30°C to-60°C

DW-40W100J/255J/380J -20°C to-40°C

It is computer-based control and displays temperature in digital with the accuracy of 0.1°C

2. Safety system

- Multiple fault alarms (overtemperature alarm, sensor fault alarm)
- Two modes for alarms (sound buzzer and alarm lamp flickering)
- All independent parts have safe earthing

3. Refrigeration system

- Subversive innovative cold deep freezing system, break through the depth of the traditional household refrigerator, -60 °C instantaneous quick-freezing, firmly lock the original fresh nutrition
- HC hydrocarbon refrigeration technology, saving half the power

4. User-friendly Design

- User-friendly design of computer control mode, intelligence without anxiety, adjustment free
- High performance insulation layer with better thermal insulation effect
- People-based design such as safety door latch

The deep freezer you obtained is probably not exactly the same as illustrated in the instruction due to continuous improvement of product, we regret for this. Content of this manual is subject to alternation without further notice.

Product installation

Installation environment

- Ambient temperature: 10°C to 32°C, with maximum beyond 32°C, the optimal temperature is 18°C to 25°C, the air conditioning system shall be used when necessary.
- Ambient humidity: below 85% Rh.
- Avoid large quantities of dust.
- Avoid mechanical sway or vibration.
- The altitude of freezer's working position: lower than 2000m.
- Input voltage: within the range of 220V±10%.
- Keep away from the radiated area and avoid the use of radiation-sensitive devices at its periphery.

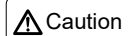

- As the freezer is sensitive to the environmental temperature. The freezer cannot operate normally if it is installed in an environment other than the above. Please use it after improving the environment.
- It is prohibited to install the freezer in the open air environment. When the freezer gets wet in the rainwater, it may cause leakage of electricity or electric shock accident.

Installation place

For normal operation and optimum performance level of the freezer, its installation place shall conform to the following conditions:

- It can not be installed in a narrow, small and airtight space, the door frame of the room for placing it shall not be less than and lower than this product, and shall at least guarantee its normal passing in and out so as to avoid any maintenance difficulty and failure of in-time repair in occurrence of machine fault, causing spoilage to the stored articles.
- The ground at the installation place shall be solid and flat.
- It shall be well-ventilated without direct sunshine.
- Do not share a socket with other equipment, the plug and socket shall be well connected.
- Do not distort or stress the power cord.
- If it is required to lengthen the power cord, the section area of the lengthened wire shall not be less than 3mm² and the length shall not be longer than 3m.
- Check the operating voltage before use, at the area where the voltage is not stable, use of a voltage regulator suitable for the motor load shall be considered for voltage stabilization. So that the normal input voltage is stabilized at 220V±10%, the power of the voltage regulator is greater than 4000W.
- The freezer shall be guaranteed with reliable earthing.
- If the power socket has earth wire, check if the earthing is good before use.
- If the socket is not furnished with an earth wire, be sure to install one by the professional engineering and technical personnel.



- Do not make freezer earthing via gas piping, water supply pipe, telephone line or lightning rod that may easily cause an electric shock.
- After installation, the power plug must be accessible to facilitate unplugging of the power cord in emergency. No articles shall block out the air vent of the freezer.

2.DW-40W100J/255J/380J

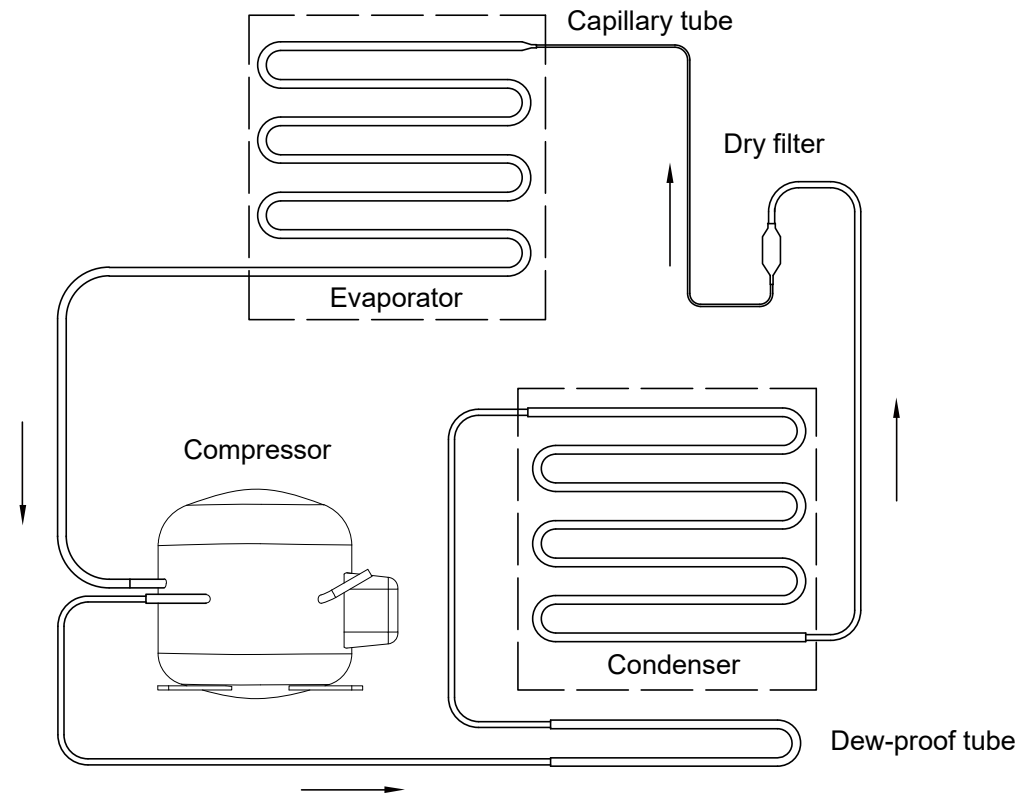

Refrigeration Schematic & Circuit Diagram

Refrigeration schematic

1.DW-60W138/258/388

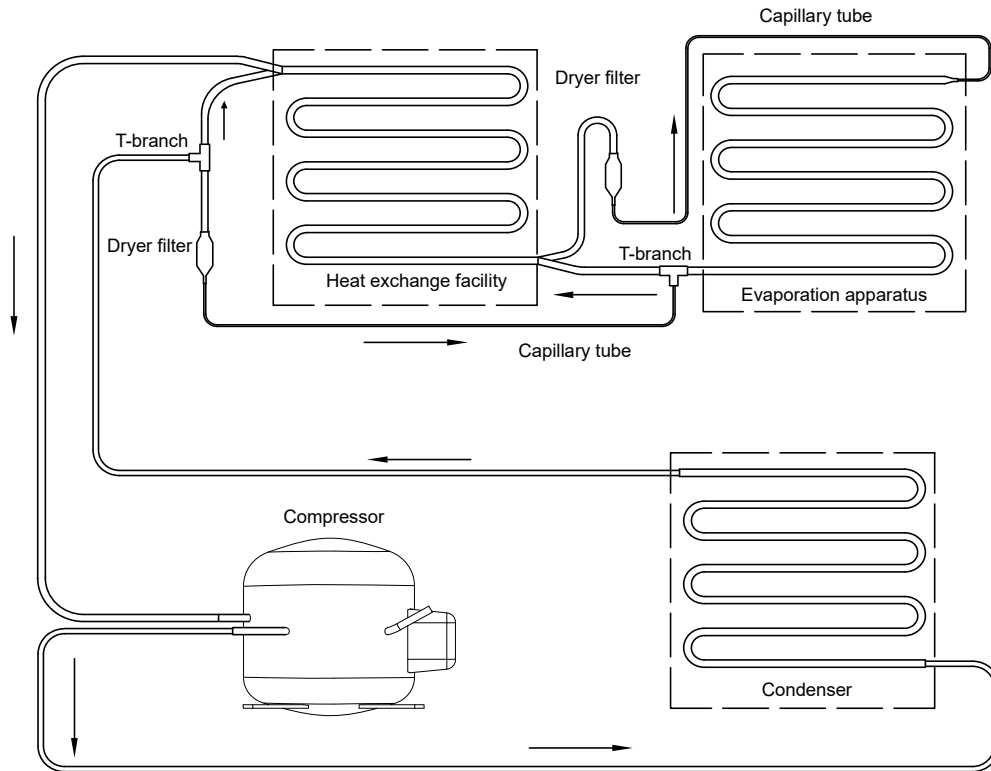

Preparation before Use

1. Disassemble all packaging materials, including the base

Take out all packaging materials of product at suitable site, including the base, and disassemble all fixed tapes or other fixtures on the freezer used for transportation safety.



For the freezer packed well, it could be moved by forklift or clipping vehicle; if you use the forklift, please insert the forks under the wooden base of the front or back side of the freezer when there is a wooden base equipped in the freezer; otherwise, if there is no wooden base, please slightly incline the freezer (with the inclination no more than 45°), and then insert the fork between the seam; if you use the clipping vehicle, you should clip the freezer together with the base, and should only clip the sides of the freezer.

2. Check the accessories shipped with the equipment

Please check the articles inside the bin as per the packing slip, contact the after-sale service in time in case of any discrepancy.

3. Select appropriate site for placement

In order to keep the freezer under appropriate condition for ventilation, please place it according to the requirements as follows:

- For the freezer, besides 30cm distance kept surrounding to it, 60cm should be kept apart from its top so as to close the door normally;
- In order to keep the operation stable, please keep the placing site flat and solid.

4. Leave the unit stand before powering up

Do not turn on the unit immediately after it is situated on site. Keep the unit standing for 24 hours before powering up the unit.

Initial power-on

Please observe the following rules when conducting initial start-up and continuous running:

Connect the power cord to the dedicated socket of proper gauge when the bin is empty, make sure the power supply is 220V~/50Hz.

Power on, and set the temperature required without putting any article in the empty freezer, and then observe that whether the freezer could be turned on or off under normal condition for over 24 hours, in order to confirm that the performance of freezer is normal.

Start putting articles gradually into the freezer after completing a thorough inspection of the freezer.

- A person shall be specially assigned for daily check and record of the product operating conditions, in case the temperature inside the bin is on the high side or on the low side, just transfer the articles to the other freezers till the fault is removed and then replace back the articles.
- Before putting any article in the freezer, please confirm that the temperature required for the article is consistent with the temperature range of this product in advance, in order not to damage the article due to the failure of this product to reach to the temperature required for the article.
- The indicated temperature of this product may have a certain difference with the actual temperature inside the bins due to refrigeration inertia, this is normal.
- The temperature within the topside drawer of freezer would be relatively higher than that in other drawers, so, for any article with strict requirements for temperature should be placed in other drawers as possible.
- All the freezers are of storage equipment, and it is strictly forbidden to put excessive articles that are relatively too hot in one go, this will cause long time of running of the compressor without stop, slow drop of temperature, thus affecting service life of the compressor, the articles must be put in batches so that the temperature drops in steps till the required temperature is reached.
- Do not use any mechanic tool or other means without permit from manufacturer to accelerate the process of defrosting.
- Do not spoil the refrigerating circuit.
- Inside the freezer, do not use the electric appliance without production permission.

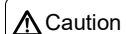

Any of the following event will be normal, please do not worry about any of it:

- For initial use or start-up, the working time of refrigerating system will be longer and the noise will be more serious, and under the normal condition, you may find out sound like liquid flow, which is caused by the circular flow of refrigerating fluid within the tube;
- There might be a difference between the temperature displayed on the freezer and that at the center of freezer, that's because the sensor is not located at the center. However, the displayed temperature will gradually be closed to that at the center after stable operation of the freezer;
- For radiating tubes are equipped in the outer shell of freezer, the surface temperature of shell will be very high when the freezer is being operated.

FAQ



If you have any questions about the operation of the unit, please refer to the following first. If an issue persists, contact your after sales office.
Do not maintain and dismantle the freezer by yourself!

| Fault | Troubleshooting |
|---------------------------|---|
| The freezer does not work | Whether the power connection is normal or not |
| | Whether the supply voltage is too low or not |
| | Check whether all the temperature settings are normally |
| Poor cooling | Whether the ambient temperature is too high? |
| | Whether the external door is closed well or not (the frost between the bin and the door seal might stop the door being closed tightly) |
| | Whether the temperature setting is correct or not |
| | Whether the freezer is kept away from direct sun shine or not |
| | Whether the freezer is closed to any heat source or not |
| | Whether the rubber hole cover and insulating material for through hole used for test are in place or not. |
| | Whether too many articles with high temperature are put into the freezer at one time or not |
| High noise | Whether the freezer is placed on the solid floor or not |
| | Whether the outer shell of freezer contact with anything or not |
| | Whether the freezer is under low-temperature operation status (for it will make some noise if the temperature within it becomes higher due to overload, which will be reduced gradually when the temperature becomes lower) |
| | Please check that whether the noise is made by the compressor (the noise from compressor of low-temperature equipment will be higher than that of home appliance) |
| | Noise caused by beat (which might be caused by quick cooling shrinkage of parts within equipment, so the temperature should be reduced gradually other than sharply reduction within a short time) |

Operation after a power failure

The freezers can retain their operation parameters when there is power outage. When the power recovers, they will continue to operate based on the saved parameters.

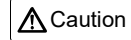

Caution

- Under outage or other fault, the freezer would stop and the inner temperature will rise. If the power could not be recovered in a short time, please take out the articles and store them by other means, in order to avoid any loss caused by article damage.
- Once the power of the freezer is cut off, wait for over 5 minutes before it is reconnected so as not to damage the compressor or the system.
- Pull out the power plug when the freezer is not in service for a long time and turn off the battery switch if applicable, so as to prevent electric shock, leakage of electricity or fire due to aging of the power cord.
- If the freezer is left unused for a long time in an unattended area, make sure that children will not approach the freezer and the freezer door can not be closed completely.

Name of parts



Cleaning maintenance

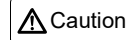

Turn off the power before any maintenance work is performed.

Freezer cleaning

1. Clean the freezer once a month. Regular cleaning can keep the appearance of the freezer a brand new look.
2. Wipe out the dust on shell, chamber and all the accessories of the freezer with a dry cloth. If the freezer is too dirty, remove the dirt with a clean cloth dipped with neutral detergent and wipe out the residues with a wet cloth. Then wipe with a dry cloth.
3. Do not pour water on the shell or in the chamber of the freezer. Otherwise, it may damage the insulation of the electrical equipment and may lead to the occurrence of fault.
4. Mechanical compressors are hermetically sealed. They do not need lubrication.
5. Conduct defrosting or deicing for the inner wall once every month.

Defrosting for inner wall

After under operation for a certain time, the frost will be formed on the inner wall of freezer, which might affect the normal refrigerating effect if it is too thick, and might consume more energy. Therefore, after a certain time of operation, when the thickness of frost reaches to 5mm around, you should use the attached defrosting shovel to clean it according to the following steps.

- Take out the articles kept in the bin and move to appropriate site;
- Switch off the power switch;
- Open the outer and inner doors for a while in order to defrost naturally;
- After frost melts well, discard the water from the drawers or drain it from the drainage hole;
- Dry the bottom of bin with a dry cloth;
- Restart the equipment after the bin is cleaned well;
- Put all articles back in the bin that has already been cooled down.



- Do not use knife or screwdriver or similar tools with sharp edges to defrost.
- Defrosting should be carried out once per month, up to once per three months.

Discarding Disposal of Freezer



- If the freezer is left unused for a long time in an unattended area, make sure that children will not approach the freezer and the freezer door will not be closed completely.
- The scrap disposal should be carried out by corresponding staff, and the door should be demolished in order to prevent any accident such as asphyxia.

Alarm

1. When the temperature captured by sensor is higher than +5°C (or higher than the setting value of high-temperature alarm), "AH" and temperature will be alternately shown; when the temperature captured by sensor is lower than -5°C (or lower than the setting value of low-temperature alarm), "AL" and temperature will be alternately shown.

2. For any short circuit, open circuit, or fault, or incorrect connection happens on the temperature sensing probe, "Err" will be shown, and when the sensor's temperature is higher than 85°C, "EHi" will be shown, and when lower than -50°C, "ELo" will be shown. At the same time, the beeper for temperature controller will be initiated, and corresponding alarm parameter (such as Err, Ehi, Elo) will be shown on the screen correspondingly, as well as the alarm mark (without display of temperature).

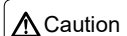

- If the temperature sensing probe is judged for error, power should be cut off, and the connection of sensing probe should be checked firstly.

- If any internal code is shown when the user is adjusting the temperature controller, please wait for 1 minute until the temperature is shown again, in order to prevent from any fault due to any change of control parameter.

Automatic recovery of alarm

1. Under alarm, the beeper alarm could be ceased by pressing any key, and the flashing alarm and remote alarm will not be ceased).

2. If the alarm condition is still available, the beeper alarm will be recovered automatically 30 minutes after ceasing.

Application method

Electronic temperature controller

An electronic digital display thermostat is installed on the control panel of the low temperature freezer, and the digital display can show the actual temperature in the cabinet after power on. The temperature has been set to -47°C after power on and -50°C after shutdown when leave factory (The temperature of DW-40W100J/255J/388J has been set to -37°C after power on and -40°C after shutdown when leave factory).

1. Electronic thermostat schematic:

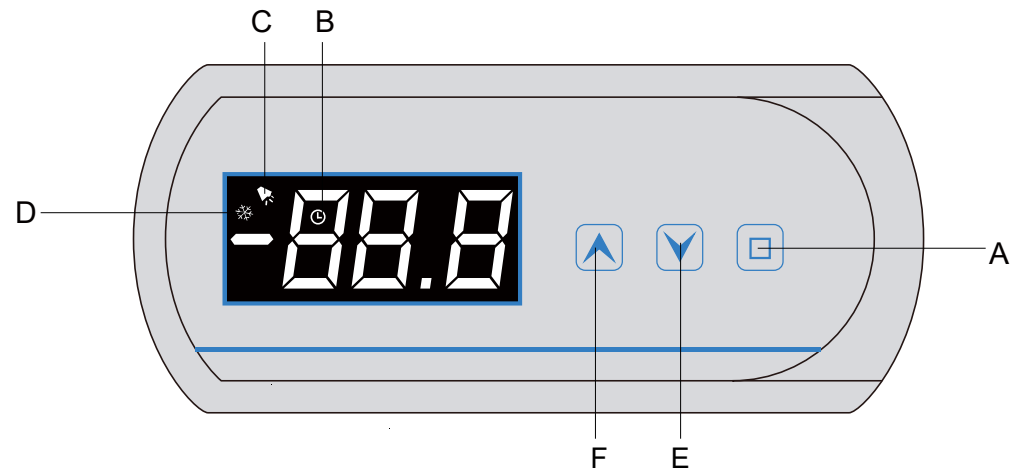

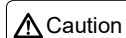

| | | | | | |
|---|------------------|---|----------------------|---|-----------------|
| A | Setting button | C | Alarm indication | E | Decrease button |
| B | Power indication | D | Refrigeration status | F | Add button |



Generally in normal use, it is no need to adjust the setting temperature. If adjusting the setting temperature, it may cause product high temperature (AH) or low temperature (AL) alarm, at this time, please adjust the temperature alarm value (AH, AL). The general high and low alarm value is within the range of ±5°C of the setting temperature.





2. Display setting temperature

A few seconds after the low temperature freezer power on, the display screen shows the current temperature in the cabinet. If you need to check the setting temperature, operate as the following steps:

- Press the  key for more than 1 second, the screen shows the setting temperature;
- Press the  key again and the screen will then show the inner temperature.

3. Setting temperature

The thermostat on the control panel of the low temperature freezer can manually set the control parameters.

- Press the  key for more than 1 second, the screen shows the setting temperature;
- Set a new temperature, the screen shows the setting temperature, press the  key or  key to adjust the required temperature;
- After the setting temperature finish, press the  key once to save and exit.

4. Error display

Suggestion: When it is judged that the temperature probe is wrong, please cut off the power .

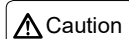

• First, please check if the connection of the temperature probe is loose. If user tune out the internal code while adjusting the thermostat, wait one minute and until it shows real temperature inside the cabinet then to operate again, that is to avoid the failure of the freezer due to the change of the control parameters.

• In the event of a power shutdown or other fault, the freezer stops temporarily and the temperature inside the freezer will rise, if it power can not recover in a short time, please consider taking out the stored items for other thermal storage and processing, to avoid loss caused by storage damage.

• Before stored items put into the freezer, please confirm in advance weather it is suitable for the low temperature you set, so as to avoid loss from stored items damaged due to the unsuitable temperature.

Test hole



1. Purpose

- Relevant test should be carried out by putting the test line in the freezer to test the articles or environment within it.
- Balance the pressure in and out of the bin in order to open the door cover easily.

2. Use method

- For any data test, you should only open the end caps of braiding at both terminal of the test hole, and then put in the test line, and stuff the hole with the end caps, which are made of rubber so that the test line will not be test line.
- If the temperature within the bin is too low, the door cover will be difficult for open, that is because the pressure within the bin is too small due to low temperature. At that time, you could open the end cap at the outer side of test hole in order to reduce the internal pressure, so that the door cover could be opened.

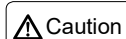

• The picture above is only a schematic diagram, and the test hole is located at different site due to different model, so please carry out relevant operation based on the model you have bought.

• After leading out the measuring line, please stuff the test hole with heat insulating materials again, otherwise the temperature within the freezer would stay high, and dew or frost would be condensed surrounding to the outside of through-hole.