



Service Manual of

ULT FREEZER

—ENERGY SAVING MODEL

MODEL	PICTURE	MODEL	PICTURE
DW-86L338J/388J /578J/728J/828J		DW-86L490J	

(QINGDAO) Haier Medical & Laboratory Products Co., Ltd.

Contents

1 Product Features	3
2 Designation of the Model.....	3
3.Product appearance.....	4
4. Parts Layout	5
5. Product Use Introduction & Product Improvement Introduction	8
6. Main Technical Parameters of the Product	12
7. Case Prevention Measures, Product Use and Daily Maintenance Knowledge	14
8.ULT J-Series Refrigerant Charge.....	17
9. Schematic Diagram and Circuit Diagram	18
10. Specific Control & Work Principle and Parameters	20
11. Refrigeration Cycle Prospective and Plan.....	26
12. Installation & Disassembly Process.....	27
13. Typical Troubles & Solutions and Common Q&A	29
14. explosive view & spare part list	35

1 Product Features

1.1 Product Features

1.1.1. Temperature set arrange $-40\sim-86^{\circ}\text{C}$;

1.1.2. Balanced pressure design inside and outside the cabinet, the door is easily opened and closed;

1.1.3. Temperature inside the cabinet, high and low temperature setting, ambient temperature and input voltage can be displayed on the display screen, High and low temperature alarm and temperature inside the cabinet can be set;

1.1.4. Temperature inside the cabinet, high and low temperature setting, ambient temperature and input voltage can be displayed on the display screen;

1.1.5. Various fault alarms (high and low temperature alarm, sensor alarm, high and low voltage alarm, alarm of bad radiating of the condenser, alarm of ambient temperature exceeding standard, LV alarm and power failure alarm);

1.1.6. Two alarm modes (voice buzz alarm and light flashing alarm), Multiple protective functions (startup delay protection, LV compensation protection and HV compensation protection);

1.1.7. It has network functions, provided with RS-232 data interface, to connect the computer, then the temperature inside cabinet can be displaced via computer, to display the alarm information. The temperature can be controlled by computer and whether the monitoring equipment is normal;

1.1.8. 5 v power supply output function, easy to use this power supply power directly to the wireless network module;

1.1.9. It has the remote alarm function, to connect the alarm equipment to realize alarm function of other room;

1.1.10. with USB data storage module, Our products can store the high and low temperature in the oven set temperature and real temperature, environment temperature and voltage, it can store data more than 10 years;

1.1.11. Equipped with castor, flexible, portable, can lock, sustainable, and according to the demand for fine-tuning;

1.1.12. Configurable recorder, network monitoring system, SMS, stainless steel shelf.

2 Designation of the Model

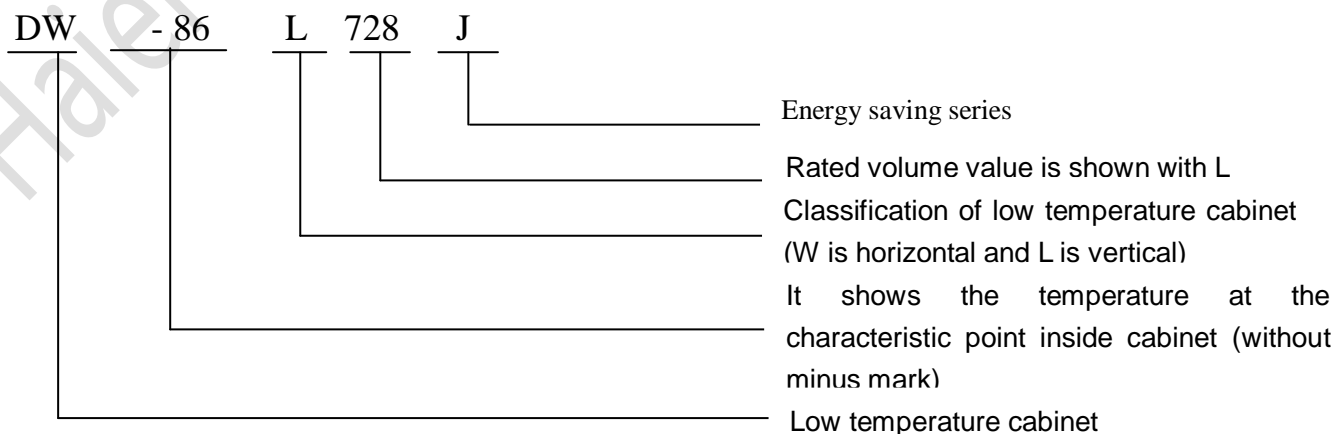

3.Product appearance

3.1 Model: DW-86L578J/728J/828J



3.2 Thin model: DW-86L338J/388J



3.3 Double door: DW-86L490J



4. Parts Layout

4.1 Display Panel

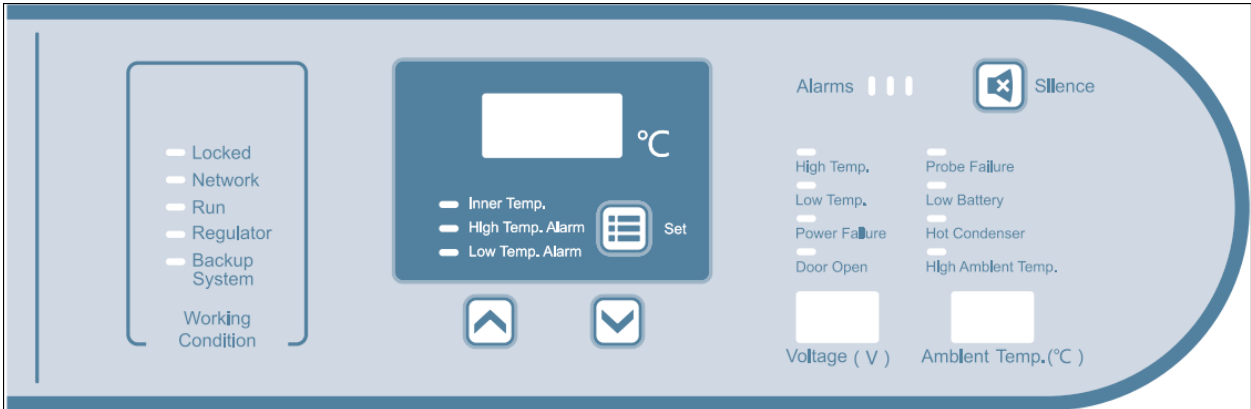

4.2. Structure of the cabinet



Haier Technical Document



The cover of the main temp. sensor

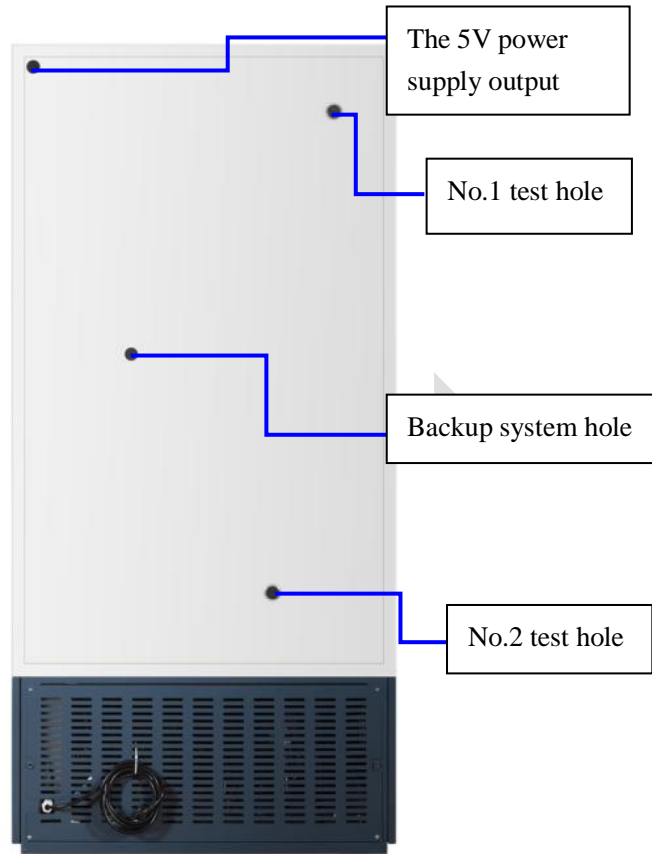

Balance pressure valve

Haier Technical Document

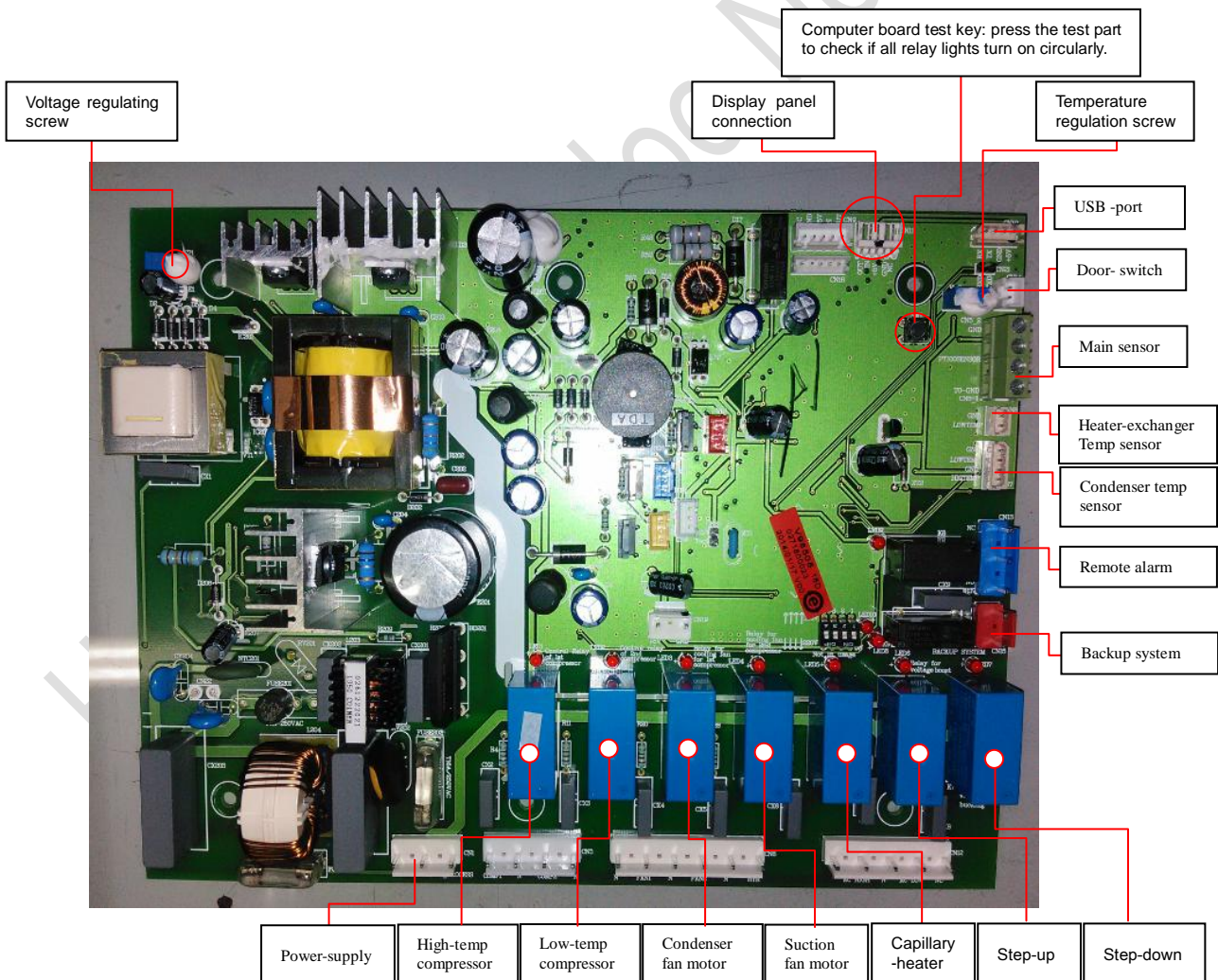
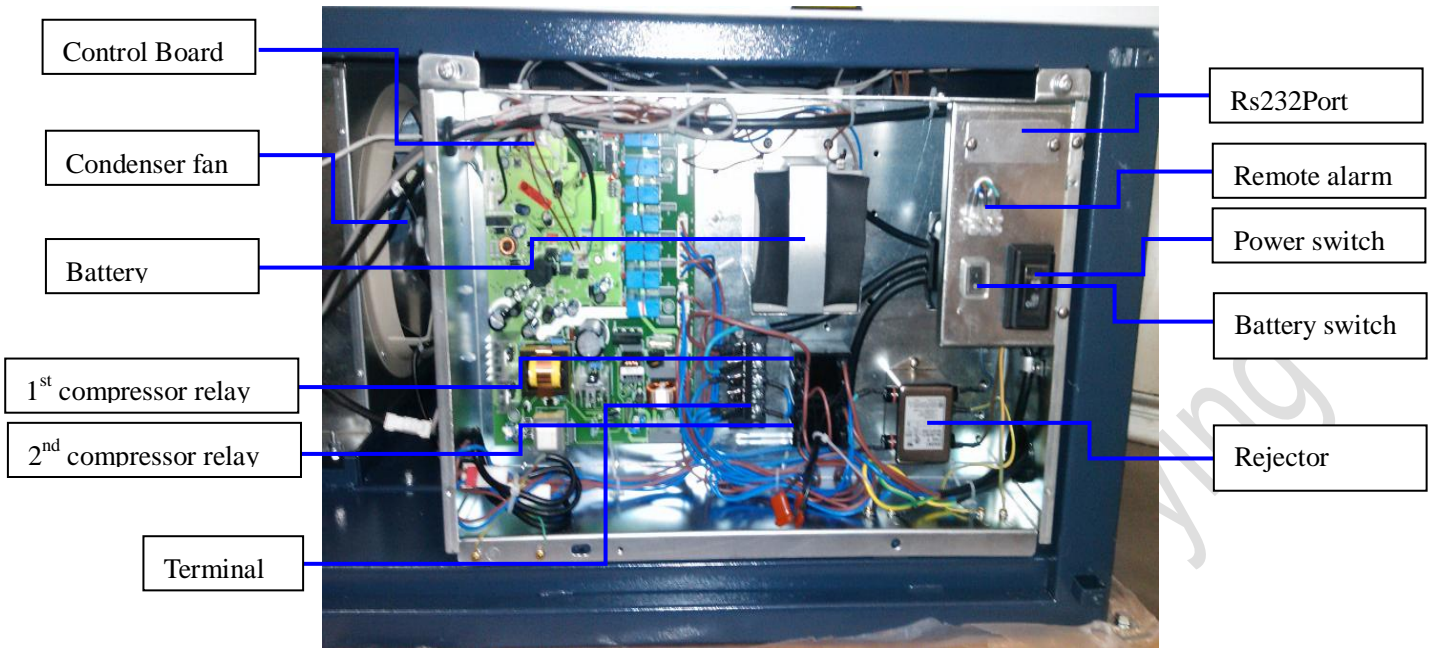

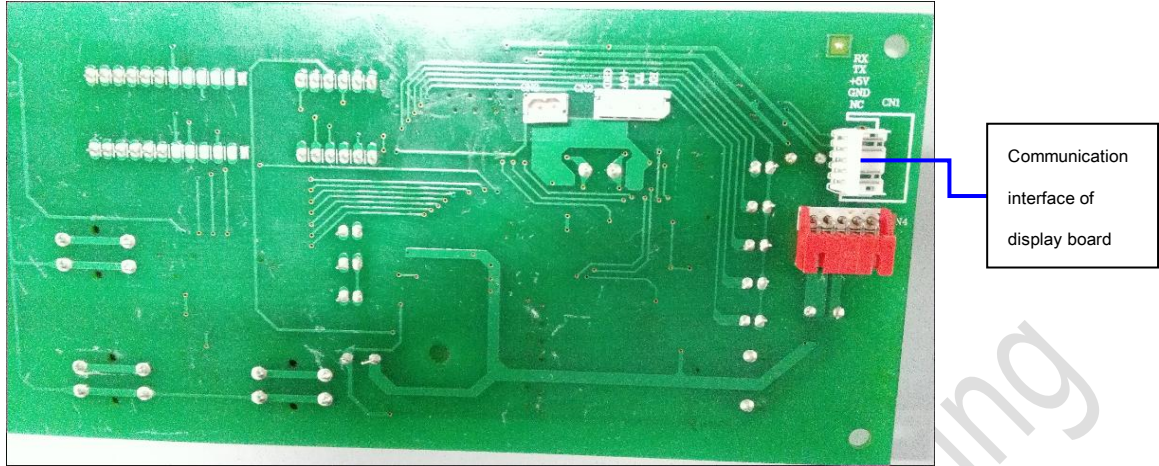

4.4 System architecture



5. Product Use Introduction & Product Improvement Introduction

5.1 Unlocking:

Firstly, press the key "UP" or "DOWN". When "00" is displayed on the display panel, adjust the key "UP" to "06" ("06" is the password) and then press the key "Set" for 3s. When the lock indicator turns off, you can unlock.

5.2 Temperature Setting Operation:

Press the key "Set" under the unlocking state, and then select the key "Set the temperature in the Freezer", "Set the high temp. alarm" and "Set the low temp. alarm" respectively. After their indicators turn on, press the key "UP" or "DOWN" to regulate the temperature.

5.3 Notes

5.3.1 After you install or move the equipment for the 1st time, please rotate its horizontal trundles

Haier Technical Document

clockwise to make them stand on the ground and ensure the freezer does not move while using. After installation and fixation, the freezer shall be switched on for use 24h later.

5.3.2 The ambient temperature shall be kept below 28°C. (If the ambient temperature is higher than 32°C, the cooling efficiency will go down quickly and the compressor might be damaged or its service life might be shorter if the ambient temperature exceeds 32°C for a long time. Therefore, we advise you install an air-conditioner in the room of the product.)

5.3.3 A single freezer shall be equipped with an independent socket and the maximum current borne by the power socket shall exceed 16A and the socket shall be grounded reliably.

5.3.4 When you switch on the freezer, firstly please turn on the battery switch in the electric control cabinet of the freezer. If you want to shut down the freezer for a long time, please switch off the power supply and then turn off the switch.

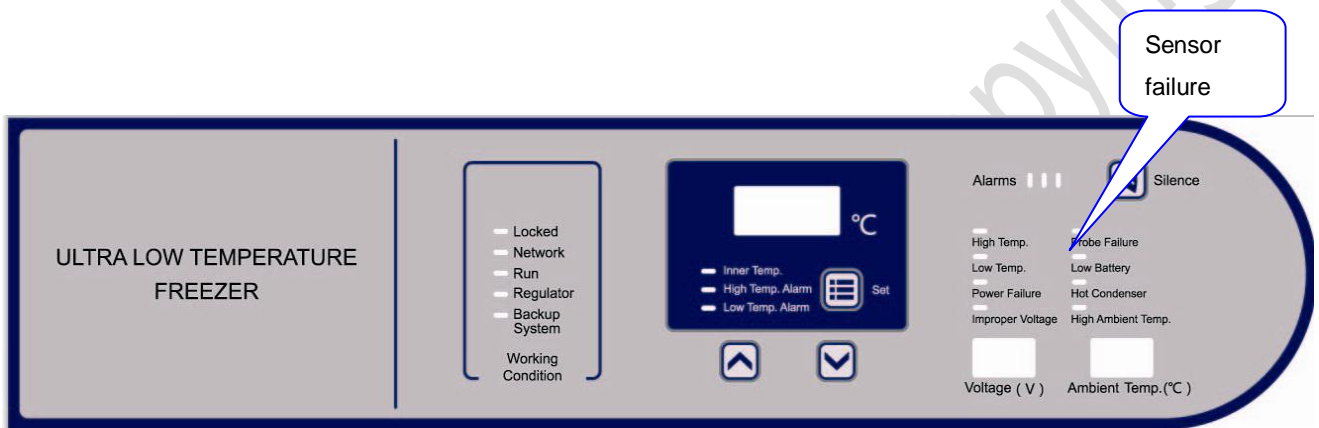

5.3.5 The door of the low-temperature freezer shall not be opened over 1min. and the icy water on the sealing strip of the door shall be mopped and cleaned to ensure the good sealing effect.

5.3.6 In order to prolong the service life of the equipment and reduce its energy consumption, we advise you set its optimal temperature between -50°C and -80°C when you use it, on the premise that the safety of preserved goods is ensured.

5.3.7 This product is used for preserving goods at low temperature but not for the quick-freezing purpose. It shall not be used for quick-freezing a lot of goods or large-volume liquid goods forcefully.

5.3.8 If the machine does not cool down after power is on for 2-3h, please switch off the power supply and contact the local after-sales service as soon as possible.

5.3.9 In case of an alarm failure or other failures, please clear the failure according to the instruction on the display panel. If there is no instruction or the failure cannot be cleared, please do not disassemble the freezer by yourself. Please contact after-sales service in time and ask professional maintainers to help you clear the failure.

5.4 Failure Code Inquiry

1) When the machine detects that the result of the condenser temperature minus the ambient temperature is $\geq 13^{\circ}\text{C}$ (for 5min. continuously), the "hot condenser" indicator turns on and the machine makes the relevant silence alarm. After the power supply is on, the indicator does not turn on and the machine does not make a silence alarm in 3h.

2) When the sensor has a failure, the indicator of the "sensor failure" turns on;

3) When the main sensor has a failure, the failure code "E2" of the main sensor and the actual temperature are displayed alternatively on the display panel.

Haier Technical Document

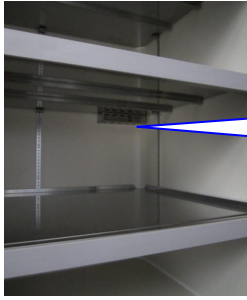

Inward main sensor E2

4) When the condenser sensor has a failure, the failure code “E1” of the main sensor and the actual temperature are displayed alternatively on the display panel.



Condenser sensor E1

5) When the ambient temperature sensor has a failure, the failure code “E0” of the main sensor and the actual temperature are displayed alternatively on the display panel.



Ambient temperature sensor failure E0

6) When the heat exchanger sensor has a failure, the actual temperature and the failure code “E3” of the heat exchanger sensor display alternatively on the display panel. When you select -86 and “E3” appears, after you press the button for clearing the silence alarm for 5s, “E3” disappears. After “E3” displays, after the high temperature compressor is started, the low temperature compressor will start with a 1min. delay.



The heat exchanger probe foams at the bottom inside the freezer.

E3 at the terminal of the heat exchanger sensor

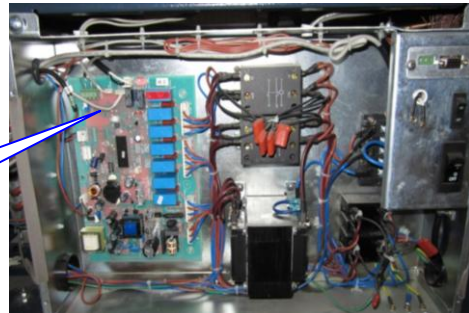

7) When the temperature detected by the heat exchanger sensor is $\geq 90^{\circ}\text{C}$, the alarm displays E4.

Remark: (If the product has no heat exchanger sensor from -25°C to -50°C , failures E3 and E4 will not

Haier Technical Document

happen to it.)

(If the product has an independent backup system, failures E0, E1, E3 and E4 will not happen to it.)

Alternative display time: the actual temperature is displayed for 6s and the failure code is displayed for 2s.

5.5 Probe resistance changes with the change of the temperature (probe type: NTC, mainly for ambient temperature sensor, condenser temperature sensor and heat exchanger sensor)

Temperature (°C)	Resistance (KΩ)	Temperature (°C)	Resistance (KΩ)	Temperature (°C)	Resistance (KΩ)	Temperature (°C)	Resistance (KΩ)
-40	63.3	-19	17.8	2	5.8	23	2.1
-39	59.4	-18	16.8	3	5.5	24	2.0
-38	55.8	-17	15.9	4	5.2	25	1.9
-37	52.3	-16	15.0	5	5.0	26	1.8
-36	49.2	-15	14.2	6	4.7	27	1.8
-35	46.2	-14	13.4	7	4.5	28	1.7
-34	43.4	-13	12.7	8	4.3	29	1.6
-33	40.8	-12	12.0	9	4.1	30	1.5
-32	38.4	-11	11.4	10	3.9	31	1.5
-31	36.1	-10	10.8	11	3.7	32	1.4
-30	34.0	-9	10.2	12	3.5	33	1.4
-29	32.0	-8	9.7	13	3.4	34	1.3
-28	30.1	-7	9.2	14	3.2	35	1.2
-27	28.4	-6	8.7	15	3.1	36	1.2
-26	26.7	-5	8.3	16	2.9	37	1.1
-25	25.2	-4	7.8	17	2.8	38	1.1
-24	23.8	-3	7.4	18	2.7	39	1.0
-23	22.4	-2	7.1	19	2.5	40	1.0
-22	21.2	-1	6.7	20	2.4	41	1.0
-21	20.0	0	6.4	21	2.3	42	0.9
-20	18.9	1	6.1	22	2.2	43	0.9

Probe resistance changes with the temperature change (probe type: PT100, mainly for the temperature sensor in the freezer)

Haier Technical Document

Temperature (°C)	Resistance (Ω)	Temperature (°C)	Resistance (Ω)	Temperature (°C)	Resistance (Ω)
-140	43.9	-70	72.3	0	100.0
-130	48.0	-60	76.3	10	103.9
-120	52.1	-50	80.3	20	107.8
-110	56.2	-40	84.3	30	111.7
-100	60.3	-30	88.2	40	115.5
-90	64.3	-20	92.2	50	119.4
-80	68.3	-10	96.1	60	123.2

6. Main Technical Parameters of the Product

6.1 Technical Parameter Table

Model	DW-86L578J	DW-86L728J	DW-86L338J	DW-86L388J
Technical Data				
Cabinet Type	Upright, Simple Door			
Climate Class	N			
Controller	Microprocessor			
Display	LED Digital (Minimum Adjustment 1°C)			
Temp Sensor	Thermistor Temperature Sensor PT100			
Parameters				
Capacity(L)	578	728	338	388
Power Supply (V/Hz)	220~240/50	220~240/50	220~240/50	220~240/50
Power (W)	900	1000	900	1000
Electrical Current	9	10	7.5	8
Interior Dimension (W*D*H)	620*716*1310(mm)	766*716*1310(mm)	465*630*1165(mm)	465*630*1310(mm)
Exterior Dimension (W*D*H)	895*980*1980(mm)	1041*980*1980(mm)	812*893*1846(mm)	812*893*1980(mm)
Net/Gross Weight	300/335	345/380(kg)	238/278(kg)	255/286(kg)
Material				
External Material	Color Coating Cold Plate Steel			
Internal Material	Color Coating Cold Plate Steel			
Heat preservation Material	VIP+CFC Free Foaming Agent			
Door Thickness	90mm		90mm	
Enclosure Thickness	90mm		130mm	
Outside door sealing	Four Seal On The Outside Door Seal Strip		Two Seal On The Outside Door Seal Strip	

Haier Technical Document

structure		
Inside door sealing structure	One Seal On The Interior Door Seal Strip	One Seal On The Interior Door Seal Strip
door lock buckle	Y/1	
Product Accessories		
Shelves/Inner Doors	3/4	3/2
Shelves(W*D)	602*680	750*680
Castor / Test Hole	4/2	4/2
Compressor type / brand / quantity	totally-enclosed /SECOP/2	
Compressor Model	SC21CNX.2	
Refrigerant	HC-Free/H-R290 L-R290 R170	

Model	DW-86L828J	DW-86L490J
Technical Data		
Cabinet Type	Upright, Simple Door	Upright, Double Door
Climate Class	-40~-86℃	
Controller	Microprocessor	
Display	LED Digital(Minimum Adjustment 1℃)	
Temp Sensor	Thermistor Temperature Sensor PT100	
Parameters		
Capacity(L)	828	490
Power Supply (V/Hz)	220~240/50	220~240/50
Power (W)	1000	900
Electrical Cueurnt	10	8
Interior Dimension (W*D*H)	870*716*1310 (mm)	590*630*1310 (mm)
Exterior Dimension (W*D*H)	1145*980*1980 (mm)	860*900*1980 (mm)
Net/Gross Weight	380/410 (kg)	295/335 (kg)
Material		
External Material	Color Coating Cold Plate Steel	
Internal Material	Color Coating Cold Plate Steel	
Heat preservation Material	VIP+CFC Free Foaming Agent	
Door Thickness	90mm	
Enclosure Thickness	90mm	
Outside door sealing structure	Four Seal On The Outside Door Seal Strip	
Inside door sealing structure	One Seal On The Interior Door Seal Strip	

Haier Technical Document

door lock buckle	Y/1	Y/2
Product Accessories		
Shelves/Inner Doors	3/4	
Shelves(W*D)	854*680	574*596
Castor / Test Hole	4/2	
Compressor type / brand / quantity	totally-enclosed /SECOP/2	
Compressor Model	SC21CNX.2	
Refrigerant	HC-Free/H-R290 L-R290 R170	

6.2 Product Nameplate

DW-86L578J

Haier		CE 0197	
Ultra Low Temperature(ULT) Freezer			
Model:	DW-86L578J	Refrigerant:	High Stage: R290:150g
Inner Temperature:	-40℃-86℃		Low Stage: R290:5g
Effective Volume:	578L		R170:80g
Rate Voltage:	220-240V~	Power Connection Type:	Y
Rate Frequency:	50Hz	Foaming Cabinet:	CP/IP
Power Input:	900W	Manufacture Date and No.:	in the Barcode
Climate Class:	N		
Weight:	300kg		
Anti-shock Safety Classification:	I		
Haier Medical and Laboratory Products Co.,Ltd. Haier Industrial Park,Economic Technology Development Zone, Qingdao 266510.P.R.China			

7. Case Prevention Measures, Product Use and Daily Maintenance

Knowledge

7.1 Refrigeration Principle of ULT Freezer:

The ultra-low temperature freezer is equipped with a cascade refrigerating system normally composing of two or more refrigerating systems, i.e. low temperature stage and high temperature stage. For the high temperature stage, the medium-temperature refrigerant is used; for the low temperature stage, the low-temperature refrigerant is used. Each part is a complete refrigerating system, a cooling evaporator is used for linking the two parts together, and it is an evaporator of not only the high temperature stage but also the low temperature stage. The low temperature refrigerant absorbs heat from the cooled object in the evaporator of the low temperature system and then transfers the heat to the refrigerant in the high temperature system through the cooling evaporator, and then the refrigerant in the high temperature system transfers heat to the cooling medium in the high temperature condenser.

7.2 ULT Freezer Use Method

Use Method:

Haier Technical Document

After the ULT freezer is used for the 1st time or moved or switched off (including power failure) over 10h, check it before being used again (or switched on again). Check and test if it is qualified.

Low temperature freezer use method:

- 1) The freezer shall be switched on only after it is unmoved for 24h.
- 2) Keep the freezer empty and switch it on. Firstly, reduce the temperature of the freezer to -40°C by stage. After the freezer is switched on and off normally, reduce its temperature to -60°C. 8h later, reduce its temperature to -80°C and observe if the freezer is normal after being switched on for 24h. If yes, prove if the freezer is normal.
- 3) After confirming the freezer is normal according to operation steps in part 2), you can put goods into the freezer. In principle, goods to be stored at -60°C shall not exceed 1/3 of the container capacity.
- 4) Taboos: All low temperature preservation containers shall be low temperature preservation equipment and used for preserving low temperature goods but not for quick-freezing high temperature plasma products. It is strictly forbidden to put too many relatively hot goods into the freezer. Otherwise, the compressor will run continuously for a long time and might burn easily and goods in the freezer might be damaged if the temperature does not go down constantly. Goods shall be put into the freezer in batches and the temperature shall be reduced step by step, until it reaches the low temperature you need!!!

7.3 Working Principle of Pressure Switch

A. Principle: When the pressure in the pressure switch pipe exceeds 2.1MPa, the contact is disconnected, the low temperature freezer switches off and the pressure goes down. When the pressure drops to 1.35MPa, the contact is connected and the low temperature freezer switches on. When the pressure exceeds 2.1MPa, the contact is disconnected again and the circulation starts sequentially.

B. Notes: When the pressure switch is burnt, put a wet towel on it and keep the temperature no more than 100°C. Parameters of this pressure switch are not adjustable.

C. Parameters: 220V, 50Hz, contact capacity: 6A.

7.4 Refrigerant Characteristics

1). Refrigerants are mixed and some of them are combustible and explosive. The charging place shall be ventilated. In case of leakage, it is forbidden to ignite or spark nearby. In case of any failure of the refrigerating system, the local after-sales service provider will analyze and feed it back and the engineer of Medical Business Division of Haier will give an instruction to the local after-sales service provider on maintenance according to the actual condition.

2) Refrigerant Code : (Energy-saving): high temperature stage: R290; low temperature stage: R290 and R170.

7.5 Refrigerant Charging Process:

7.5.1 Preparation

- 1) Refrigerant (R290, and R170.) ,R245fa, R134a (flush the cooling system)
- 2) Hansen valve
- 3) Standard electronic scale (error $\leq \pm 2g$)
- 4) Vacuum pump ($\geq 4L$)
- 5) Pressure gauge (high and low pressures shall be read at the same time) See Fig. 1.

7.5.2 System Cutoff

Haier Technical Document

- 1) Cut off the failure system from the end of the process pipe with a pipe wrench and discharge the refrigerant in the system.
- 2) Finish welding the open pipeline with the pressure gauge in 20min. after the system is cut off.

[Notes]

* This series is a two-stage refrigerant system with separated high temperature stage and low temperature stage. Do not open the two systems at the same time during maintenance and make clear which system needs to be cut off.

*If the humidity in the maintenance workshop or if it is rainy or cloudy, it is forbidden to cut off the system and each pipeline of the system which has been cut off shall be welded well at once.

*Since the machine has the strict requirement for moisture in the system, each pipeline port shall be sealed up with adhesive tape immediately after it is cut off, so as to prevent from air entering the system, and also the pipeline at each port shall be welded completely in 20min.

7.5.3 Vacuum-pumping

- 1) Connect the vacuum pump adapter with the public adapter in the middle of the pressure gauge. See Fig. 2.
- 2) Switch on the vacuum pump for vacuum-pumping and the vacuum shall be $\leq 3\text{Pa}$. See the attached notes for the reference. See Fig. 3.
- 3) When the vacuum meets the said requirement, stop pumping at high temperature firstly and quickly weld and seal up the high temperature charging pipe (the pipe cannot be sealed up when the refrigerant pressure is too high and the freezer refrigerates), and then continue vacuum-pumping for 1h at the low pressure. See Fig. 4.
- 4) After that, switch off the pressure gauge valve. Meanwhile, the machine shall be kept at the negative pressure for 1h, so as to check if the machine system is under the vacuum state. At the same time, observe if the pressure indicated by the pressure gauge goes up. Otherwise, vacuum-pumping for 1h shall be conducted again. Then, continue to keep the machine under the negative state for 1h above continuously, and stop vacuum-pumping and start charging until the pressure does not go up.

[Notes]

*The vacuum pump above 4L shall be pumped for 12h.



Fig. 1



Fig. 2



Fig. 3

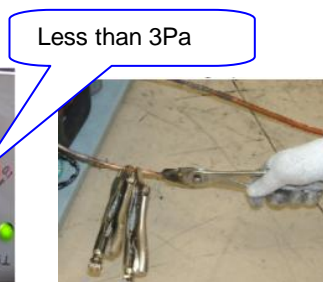

Fig. 4

7.5.4 Charging Refrigerant

- 1) When the high temperature refrigerant is filled, the machine shall be off. Firstly, fill **R290 refrigerant** and then fill **R170 refrigerant**. Please fill according to the attached table!

[Notes]

- 1) In order to ensure charging the refrigerant once in place, the steel cylinder must be put upside down for charging the above refrigerant. See Fig. 5.
- 2) When the low temperature refrigerant is filled, the machine shall also be off. Firstly, fill R290 refrigerant and then fill R170 refrigerant, and also the R170 refrigerant pressure shall be higher. Please

Haier Technical Document

strictly fill according to the attached table!

3) Seal up the charging process pipe well after charging. See Fig. 6 for the sealing effect.

[Notes]

* The low temperature refrigerant charge must be accurate, because even a tiny little difference may affect the refrigerating effect.

* The low temperature refrigerant pressure is high and the refrigerant charge is very low, so the steel cylinder valve shall be switched on slowly to avoid wasting the refrigerant.

* If the pressure of R170 refrigerant is too high and unbearable for a normal steel cylinder, R170 refrigerant shall be filled in an oxygen cylinder. When using, the outlet at the bottom of the steel cylinder shall be blocked so as to avoid refrigerant leakage and then you can use the outlet on the top for charging. When the refrigerant is filled as above, the steel bottle can be kept vertical for filling gas.

* In order to ensure that the refrigerant is filled accurately, the electronic scale must be used for weighing and charging all refrigerants.

* Once Haier headquarter discovers that the freezer makes poor refrigerating performance or fails to refrigerate or the machine is replaced because of failure to meet the above requirement and operation instruction for pumping and charging the refrigerant, the double maintenance cost shall be borne by the relevant dealer to the user claiming for repairing the machine again and also the replacing machine shall be borne by the dealer if any.

* The requirement for the accuracy of the refrigerant charge (g) of the ULT freezer product series is very strict. The dealer must prepare a standard electronic scale with the tolerance of 2g before maintenance.



Fig. 5

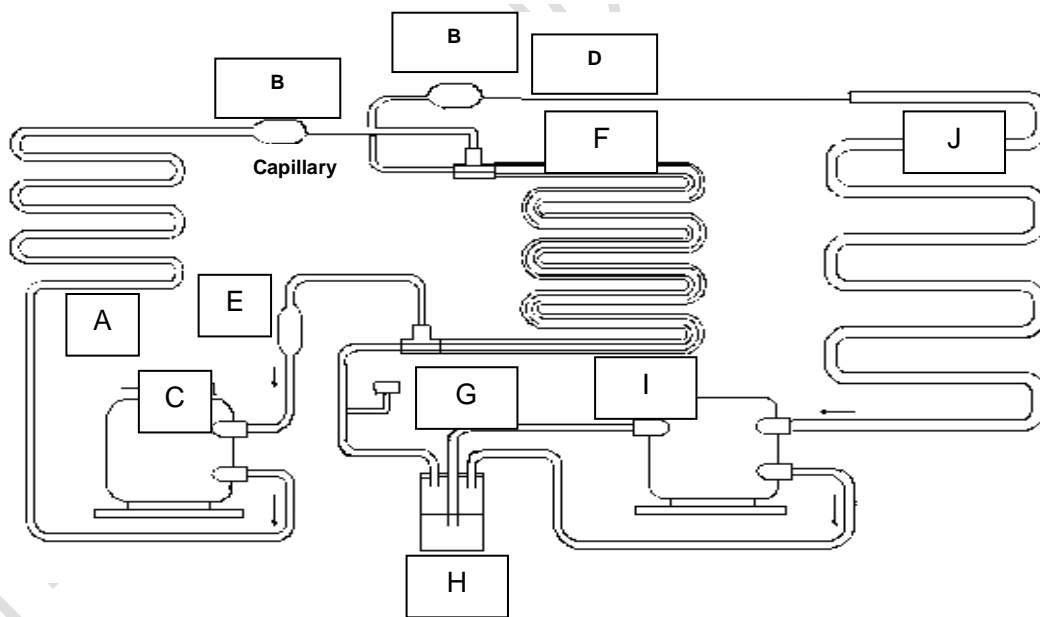
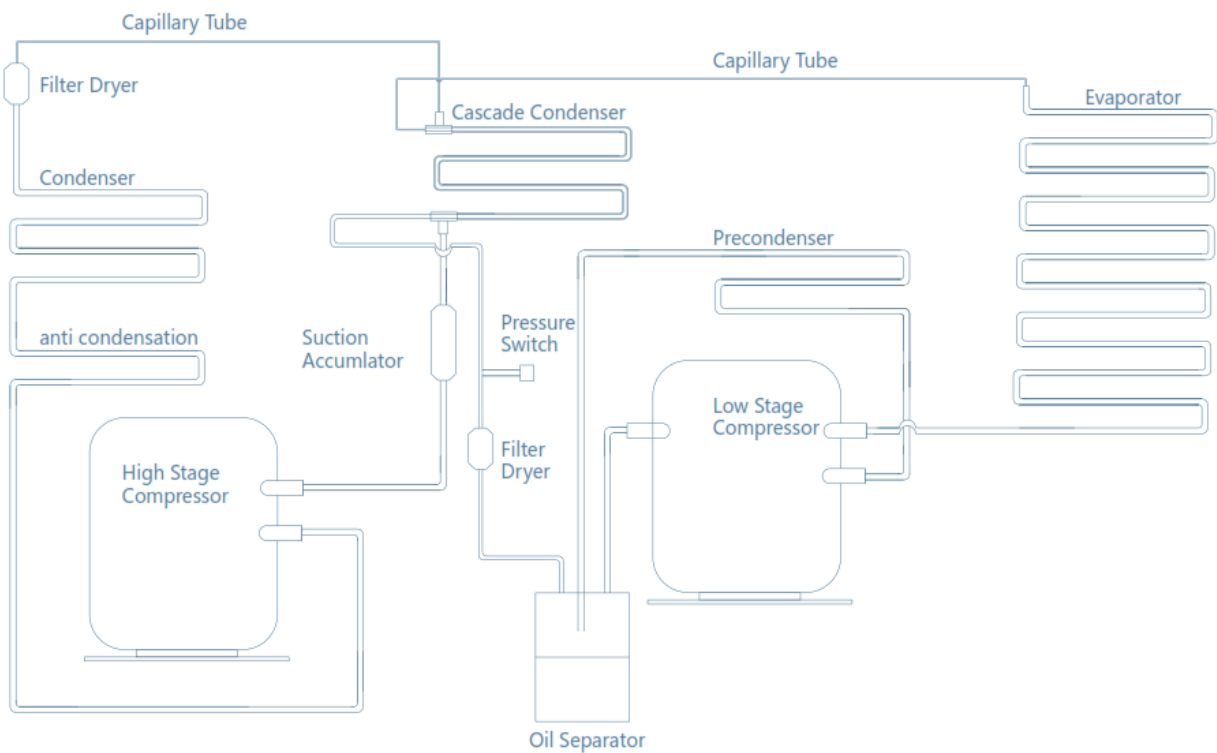

Fig. 6

8. ULT J-Series Refrigerant Charge

Model	Gas a		Gas b	
	1 st stage (g)		2 nd stage (g)	
	R290		R290	R170
DW-86L338J	150		5	60
DW-86L388J	150		5	62
DW-86L490J	150		5	90
DW-86L578J	150		5	80
DW-86L728J	150		5	90
DW-86L828J	150		5	100

9. Schematic Diagram and Circuit Diagram



- A -----Condenser
- C ----- 1st-stage compressor
- E ----- Gas-liquid separator
- G ----- Pressure switch
- I ----- 2nd-stage compressor

- B -----Dry filter
- D -----Capillary
- F -----Heat exchanger
- H -----Oil separator
- J----- Evaporator

Circuit Diagram

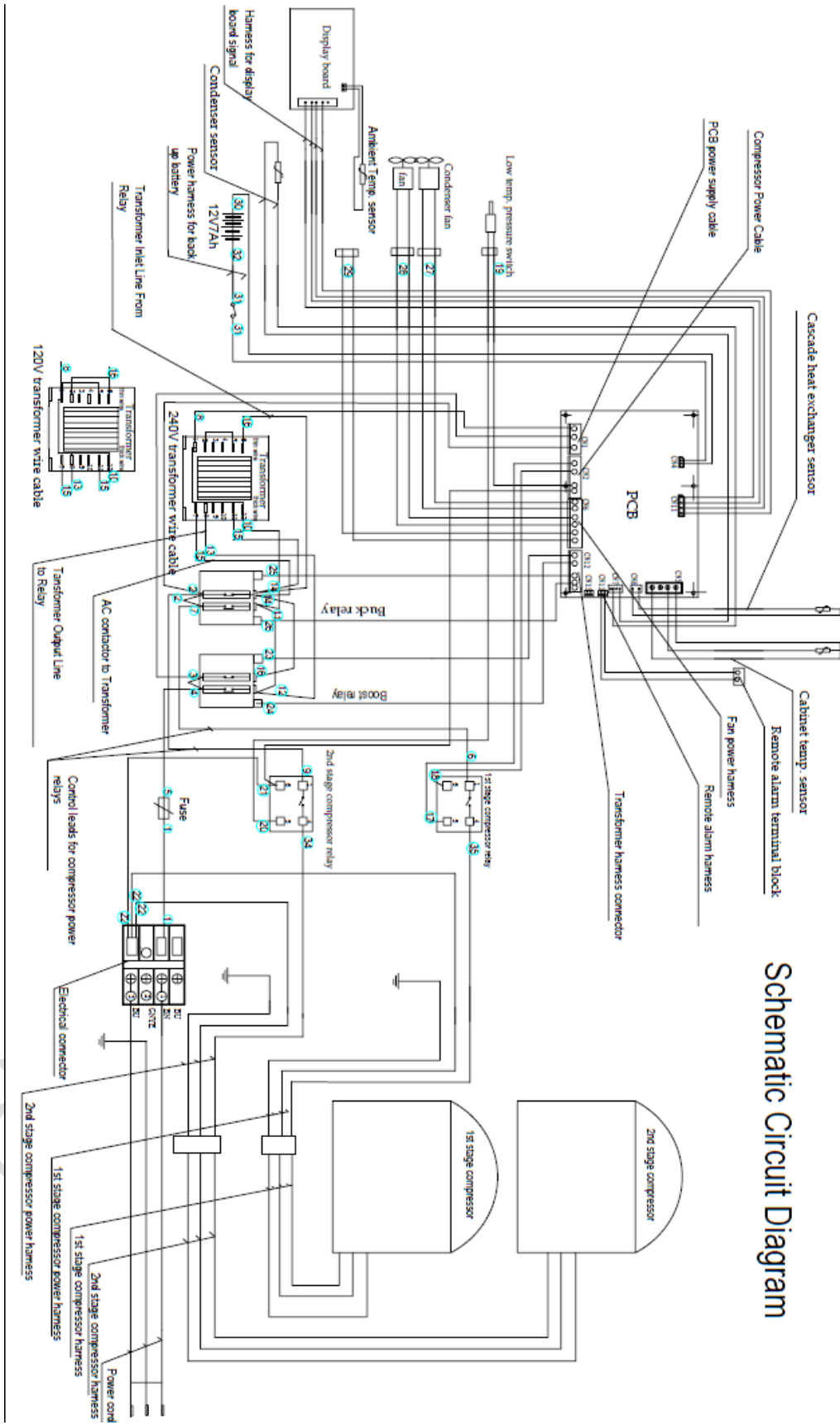

Schematic Circuit Diagram

10. Specific Control & Work Principle and Parameters

DW-86L338J-ARQ has the temperature control system with a LED computer panel for controlling the switch-on/off state of the compressor.

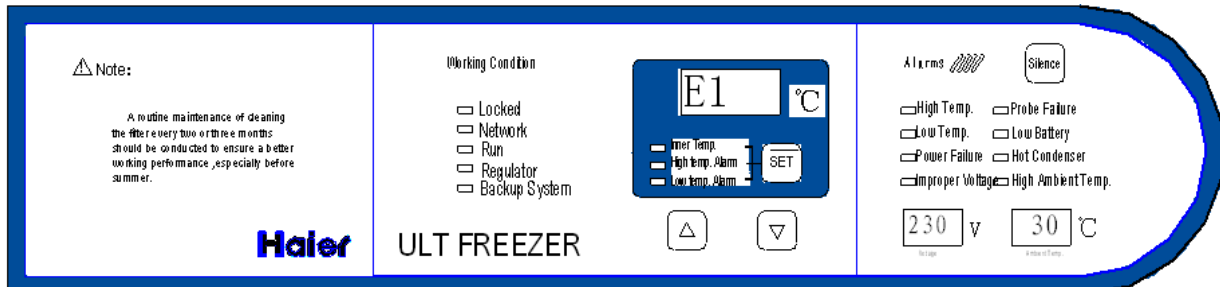

10.1 Temperature control system with a LED computer panel for controlling the switch-on/off state of the compressor

1) In order to regulate the set value, firstly unlock the machine. First, press “△” or “▽”. When the temperature set value flickers, press “△” or “▽”, input the figure “06”. Then, press the “Set” key for 5s. When the “Lock” indicator turns off, the machine is unlocked and you can set the following values. Press the “Set” key to set the temperature in the freezer, the high temperature alarm and the low temperature alarm circularly and also the relevant indicators turn on.

2) When you “set the temperature”, the temperature set value flickers in the temperature setting display area. At that time, press “△” or “▽” to change the temperature set value. After that, the machine will be locked automatically and the temperature display stops flickering if no key is operated in 10s, which means that the value has been input into the computer. Otherwise, the setting is invalid. The temperature setting scope is: -10 ~-86°C.

3) When the “high temperature alarm” is set, the temperature set value flickers in the temperature setting display area. At that time, you can press the shift or adjustment key to adjust the alarm set value. After that, the machine will be locked automatically and the temperature display will stop flickering if no key is operated in 10s, which means that the value has been input into the computer. Otherwise, the setting is invalid. The temperature set value for high temperature alarm shall neither be higher than the maximum temperature limit nor lower than the set temperature of +5°C.

4) When the “low temperature alarm” is set, the temperature set value flickers in the temperature setting display area. At that time, you can press “△” and “▽” to adjust the alarm set value. After that, the machine will be locked automatically and the temperature display will stop flickering if no key is operated in 10s, which means that the value has been input into the computer. Otherwise, the setting is invalid. The temperature set value for low temperature alarm shall neither be lower than the minimum limit temperature nor higher than the set temperature of -5°C. Otherwise, the value cannot be set.

10.2 Display and Alarm

After the freezer is switched on, it enters the starting mode, all parameters on the display panel will remain the same with data before it is switched off last time, and the actual temperature, set temperature and current voltage are displayed on the display panel.

Working condition indicators on the display panel:

If the indicator of “Locking” turns on, it means all settings are locked to avoid maloperation.

If the indicator of “Network” turns on, it means the network system is working.

If the indicator of “Run” turns on, it means the low temperature compressor is working.

Haier Technical Document

If the indicator of “Voltage Stabilization” turns on, it means the voltage supercharger starts increasing or decreasing the voltage.

If the indicator of “Standby System” turns on, it means the standby refrigerating system is working;

Alarm state indications:

- A. “High temperature indicator: if the indicator turns on, the alarm will be displayed because the temperature in the freezer is higher than the maximum temperature set value;
- B. “Low temperature indicator: if the indicator turns on, the alarm will be displayed because the temperature in the freezer is lower than the minimum temperature set value;
- C. **If the indicator of “Improper Voltage” turns on, it means the voltage is lower or higher than the normal scope and the buzzer makes an alarm. (The door opening alarm is completely substituted by the improper voltage alarm since June 2014, except DW-86W100/420.)**
- D. If the indicator of “Too High Ambient Temperature” turns on, it means the ambient temperature is higher than 32℃;
- E. If the indicator of “Sensor Failure” turns on, it means the sensor has a failure;
- F. If the indicator of “Power-off” turns on, it means the power circuit has a failure;
- G. If the indicator of “Hot Condenser” turns on, it means that the condenser is blocked by dirty things and shall be cleaned.
- H. If the indicator of “Low Battery Capacity” turns on, it means the storage battery capacity is low and shall be recharged; when the AC power is supplied, the low temperature freezer will charge the storage battery automatically.

If all alarms are given, the visual alarm will flicker immediately for high and low temperatures, and then the buzzer will start the acoustic alarm after flickering for 15min.; after the visual alarm for power failure and improper voltage flickers for 1min., the buzzer will start to alarm; when the visual alarm for hot condenser and low battery capacity flickers, the buzzer will also make an acoustic alarm at the same time; if the ambient temperature exceeds 32℃ (excluding 32℃), the indicator of “Too High Ambient Temperature” in the alarm display area will turn on and alarm but the buzzer will not alarm; if the ambient temperature exceeds 38℃ (excluding 38℃), the indicator of “Too High Ambient Temperature” in the alarm display area will turn on and alarm and the buzzer will also alarm.

The flickering light alarm will not stop until the failure is cleared; you can press “Silence” to stop the acoustic alarm of the buzzer. Then, the buzzer keeps silent for 30min. but starts to alarm again afterwards.

10.3 Setting of Special Functions:

Password Setting:

When the low temperature freezer is used for the first time, the unlocking password is “06”. After unlocking, if you press the key “Set” and “Silence” at the same time for 5s, “06” will display on the display panel. Then, you can press “▲” and “▼” to change the passwords among 05, 06, 07...29 and 30. If no key is operated is 5s after the password is set, the freezer will be locked automatically and the new password will be effective. The figures can display from 01, 02, 03....98 to 99 on the display panel.

Set the start delay time:

When the freezer is unlocking, if you press the “Set” Key and the key “▽” at the same time for 5s, when the panel displays the freezer is just switched on, the high temperature compressor will be started with a delay of 01 (1min.). Then, you can press “△” or “▽” to set the delay from 01, 02, 03 09 to 10 (optional from 1min. to 10min.) and the default delay is 1min.

Coded Lock Function

Haier Technical Document

The coded lock is optional. If the product is equipped with a coded lock, the user can log on the coded lock to become a user and input the password to unlock directly so as to realize multi-people management.

(4) When the ambient temperature is higher than 35°C, if the set temperature is lower than -82°C, the temperature will be regulated to -82°C; if the ambient temperature is lower than 30°C (including 30°C), the ambient temperature will return to the original set value.

(5) The same temperature setting method is used for high temperature alarm and low temperature alarm.

10.4 Battery Control Requirement:

A. Apply to DW-86L338J/388J/490J//578J/728J/828J

There is a storage battery power switch on this equipment and this switch shall be turned on before the freezer is switched on. As long as the switch is on, the AC equipment which meets the relevant requirement will work normally. When AC power is supplied, the equipment will charge the storage battery according to the relevant requirement.

- a. When AC power is supplied, If $U=0$ (It means the battery switch is off-status), The charge circuit will not work and low alarm will appear, So that the customer will be reminded.
- b. When AC power is supplied, Checking the voltage of the battery for 5 mins, If the condition ($0 < U \leq 10.5V$) is satisfied, it means the battery switch is on-status. The charge circuit will charge the battery for 24 hours, then checking the voltage of the battery for 5mins, if $0 < U \leq 10.5V$, it means the battery is damaged, meanwhile the low battery alarm will appear, the battery need to be relaced in time;

After 24hours charging, If $10.5V < U < 11.5V$, it means the battery is rechargeable, The charge circuit will charge the battery until the voltage of the battery reaches 12.5V.

- c. When the AC power failed, the battery will supply power to the display board, If $V_b \leq 10.5V$, The battery will not supply power to display board.

If you want to cut down the power completely, You should unplug the power cord and turn off the battery switch.

10.5. Temperature Deviation Adjustment Method:

Under the unlocking mode, if you press the Set key, the display panel will display a value for adjustment between +5 to -5°C. After that, the computer board will save the value automatically.

Example 1: -80°C is displayed on the machine of a user, but the user measures that the temperature in the freezer is just -70°C, so the difference is 10°C. In order to lessen the difference, the temperature deviation can be adjusted by +5°C. Thus, the -75°C is displayed but the temperature in the refrigerator is still -70°C. When the machine is switched on and refrigerates, the displayed temperature and the temperature measured by the user will both drop at the same time;

Example 2: -80°C is displayed on the machine of a user. The machine cannot reach lower temperature because the ambient temperature of the user is too high. However, it is required that -82°C shall be displayed. Then, the temperature deviation can be adjusted by -2°C. Thus, the temperature display is -82°C.

10.6 Condenser Fan Control:

When the compressors is on, two fans are on; when two compressors are off, two fans are on or off according to the following circumstances: if the ambient temperature is not lower than 20°C, the two

Haier Technical Document

fans will be on; if lower than 20°C, one fan will be on and the other one will be off; when the ambient temperature is lower than 12°C, two fans will be off.

10.7 Remote Alarm Function

According to the remote alarm function requirement, the freezer will have the constant ON alarm or Constant OFF alarm functions which can be selected according to the demand. In case of high temperature, low temperature or external power failure (no matter if the standby battery switch is on or off), the remote alarm function can be enabled.

10.8 Compressor Control

When power is just switched on, the time will delay according to the setting of the user (the default delay is 1min.). If the freezer meets the switch-on condition, the high temperature compressor will be started. After that, if the heat exchanger sensor temperature is not higher than -20°C in 10 minutes, the low temperature compressor will start.

When compressors are switched on and off normally, if the freezer meets the switch-on condition, the high temperature compressor will start. One minute later, if the heat exchanger sensor temperature is not higher than -20°C in 1 minutes, the low temperature compressor will start.

Normally, it takes no less than 10min. for compressors to switch on and no less than 5min. for them to switch off.

If the freezer meets the switch-off condition, there will be no output from the output terminal of the low temperature compressor and the output terminal of the high temperature compressor.

If -40°C is selected during the operation of 3.2.1, other steps are the same with the operation for -86°C except that the judgment condition for the start of the low temperature compressor is changed to 5°C (30°C for switching off).

When the freezer is supplied with strong current for the first time, after the low temperature compressor (continuously) works for 16h, it shall be turned off for 10min. forcefully and then run again automatically. If it not the first time, after the low temperature compressor runs continuously for 5h, it shall be switched off for 10min. and then run again automatically.

10.9 Voltage Calibration

The operation function of voltage calibration is added on the display panel. In detail, when the display panel is unlocked, when you press the key "Silence" and the key "▽" for 5s at the same time, the current voltage deviation is displayed and then you can press "▲" or "▽" to increase or reduce the voltage. The voltage always goes up or down by 1V and its regulation range is from -9V to 9V. The initial value of the voltage deviation is 0.

10.10 Setting Adjustment

When power is switched on for the first time, after the display panel is unlocked, if you press "Set and ▲" for 5s, the display panel will display -86. Then, if you press "▲" or "▼", -86, -150, -50, -40, 380 and 88 will be displayed circularly. If no key is operated in 5s after setting, the display panel will be locked automatically and the selected value will become valid. After you exit the selected value, the actual temperature will be displayed again. If you do not select a set value, the default will be -86. After your selection is valid, the relevant function will be implemented. Besides, the display panel has the memory function. 88 is an independent backup system.

10.11 Export USB data and time setup

(Apply to DW-86L338J/388J/490J//578J/728J/828J)

The control board has the interface to connect with USB board, The customers can export the data of the machine, the information of the data contains the real temperature of the cabinet, setup temperature, ambient temperature, voltage, high temperature alarm value, low temperature alarm

value.

PCB has automatic data collection function, it can store test data for more than 10 years, The collection frequency is 6 min

The customer can export the data to flash disk.

Exporting USB data

1. In unlocked mode, insert the USB flash drive. The temperature display shows USB, which means data is being exported.
2. When the temperature display shows ALL, exporting of the data is finished, please remove the USB flash drive.

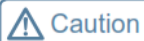

Caution

The system memory can save data for 10 years.

The collection frequency is 6min and the format of the file is .csv.

Setting the USB storage time

1. In unlocked mode, press and hold "☑" key for 3 seconds, the temperature display steadily shows "1P".
("1P/2P/3P/4P/5P" stands for "Years/Months/Days/Hours/Minutes" respectively)
2. Press "Set" key, the temperature display shows years and flashes (default value: 10). Press "☒" or "☑" key, select years. The choices are from 10 to 99. If you want to set the year 2013, select 13.
Press "Set" key to save the changes. Then, the temperature display steadily shows "2P". Follow the procedure above to set "2P", "3P", "4P" and "5P" respectively, and press "Set" key to save the changes.
Then, the temperature display will show "1P" again, and you can set 1P to 5P again.
For example: Set the time as 08:30, Aug. 16, 2013
3. After the settings are completed, press and hold "Set" for 5 seconds, the changes will be saved and exit the settings automatically. Then, the temperature display will normally show the inner temperature.

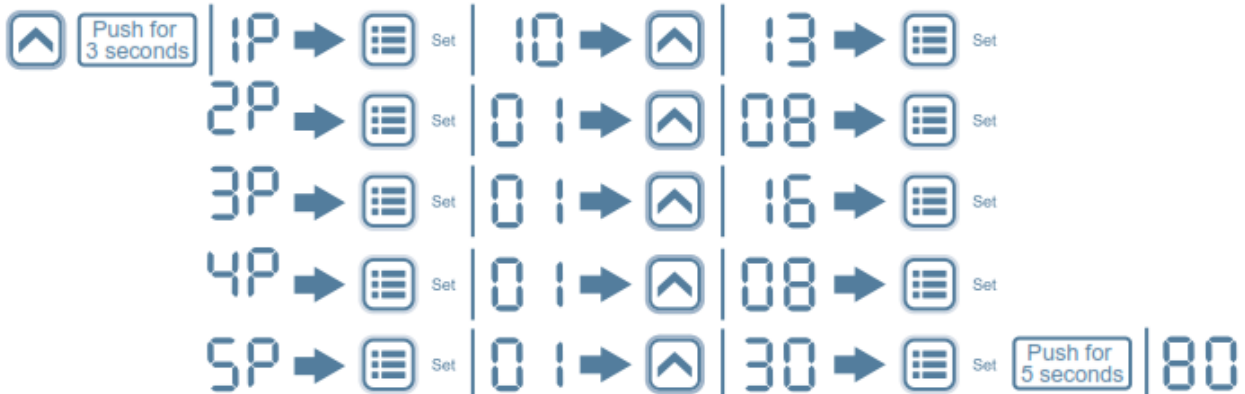

Haier Technical Document

During the above procedure setting 1P to 5P, you can use "▲" or "▼" key to adjust the settings individually.

For example: The temperature display shows 1P (Years), if you do not need to change Years (1P) and Months (2P), you can adjust Days (3P) directly.

1. Press "▲" key to select Days (3P).
2. Press "Set" key, the temperature display shows the date and flashes.
3. Press "▲" or "▼" key to adjust the current date.
4. Press "Set" key to save the change. Then, the temperature display will show Hours (4P).
5. If you need to adjust the Hours, press "Set" key to change the setting.
If no adjustments need to be made, press "▲" key, the display shows Minutes (5P), and you can make changes.
6. After having finished the settings, press and hold "Set" for 5 seconds, the changes will be saved and the settings will be automatically exited from. Then, the temperature display will normally show the inner temperature.



During the above procedure setting 1P to 5P, after finishing the adjustment of any of the settings, if no other settings do not need to be changed, you can just press and hold "Set" key for 5 seconds to save the changes and exit the settings.

The exported data is stored in a file folder, and the Name of the folder is 'USBXXXX', 'XXXX' is the serial number of the USB chip

USB70484	文件夹	2016/3/5 11:02
USB70499	文件夹	2016/3/5 11:00

10.12 Door Open alarm

When the door is opened for 5 min, The door open alarm will appear; the time of door open can be changed by manual: the rang is from 0 to 20min, default value is 5min.

Operation steps as follows:

At unlocked status, press 'silence' + 'Set' + 'UP', the LED will show '05' which means 5min, press 'UP' or 'Down' to change the value, press 'set' to save and exit.

10.13 PEP-heating function

When the temperature of the cabinet is higher than -35°C , The heater is not working; when the temperature is lower than -35°C (include -35°C), The heater will work. The voltage of the heater power is 12V.

10.14 Heating capillary function heating capillary function was cancelled at Nov.2016.

Heating capillary function has two modes, auto and manual, auto-mode is controlled by the software, Manual-mode is designed for maintain which is just for engineers.

Manual heating capillary is a good solution which can resolve the oil-blockage in the cooling pipe.

Haier Technical Document

operating steps as follows:

In locked status, press 'UP' and 'down' button at the same time for at least 5seconds, The compressor will stop running, meanwhile, the display panel will show 'H' ,After 3min the heater will heat the capillary which will keep 10min, After heating time finished, delay 3min,the compressor will work, the display panel show the temperature of cabinet. Heating capillary function finished.

10.15 DC Power failed alarm

When the switching power supply is damaged which caused by short-circuit of the isolation transformer and other reasons, The display panel will show 'EEE', the alarm indicator light will flash and the buzzer will ring.

11. Refrigeration Cycle Prospective and Plan

11.1 Refrigeration Principle

The ultra-low temperature freezer is equipped with a cascade refrigerating system normally composing of two or more refrigerating systems, i.e. low temperature stage and high temperature stage. For the high temperature stage, the medium-temperature refrigerant is used; for the low temperature stage, the low-temperature refrigerant is used. Each part is a complete refrigerating system, a cooling evaporator is used for linking the two parts together, and it is an evaporator of not only the high temperature stage but also the low temperature stage. The low temperature refrigerant absorbs heat from the cooled object in the evaporator of the low temperature system and then transfers the heat to the refrigerant in the high temperature system through the cooling evaporator, and then the refrigerant in the high temperature system transfers heat to the cooling medium in the high temperature condenser.

11.2 Refrigeration Cycle Prospective and Plan

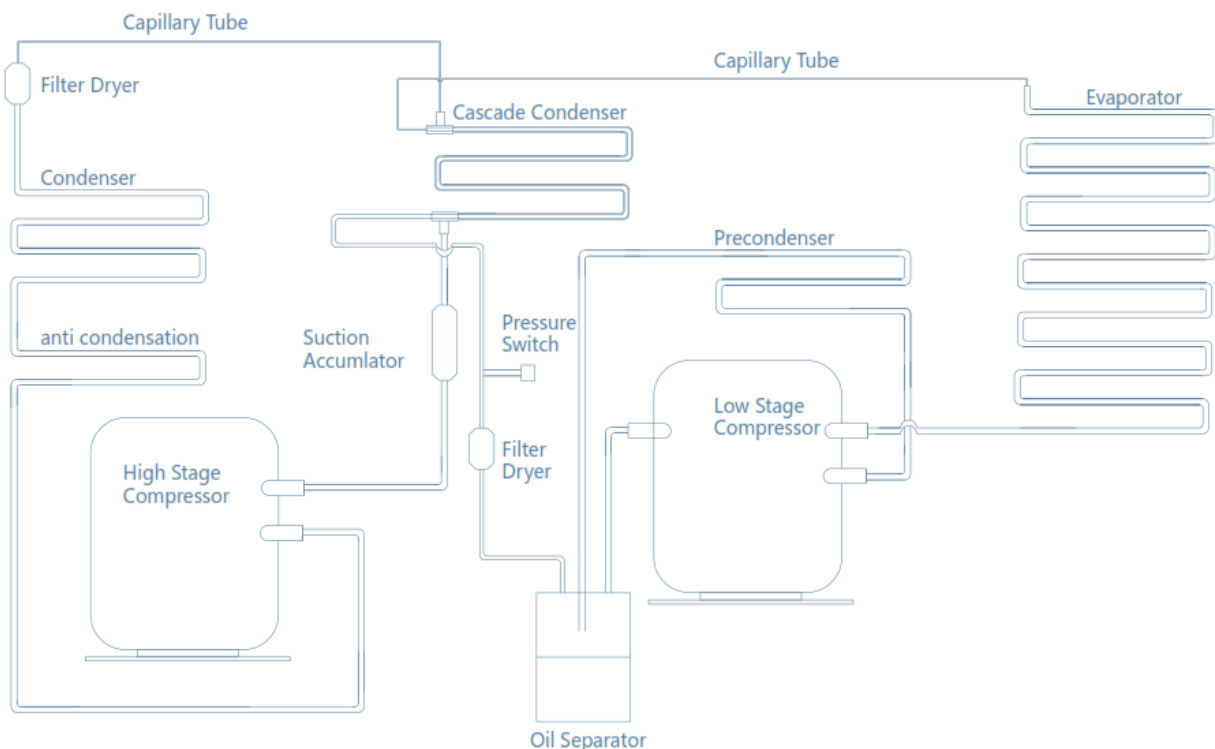

Haier Technical Document

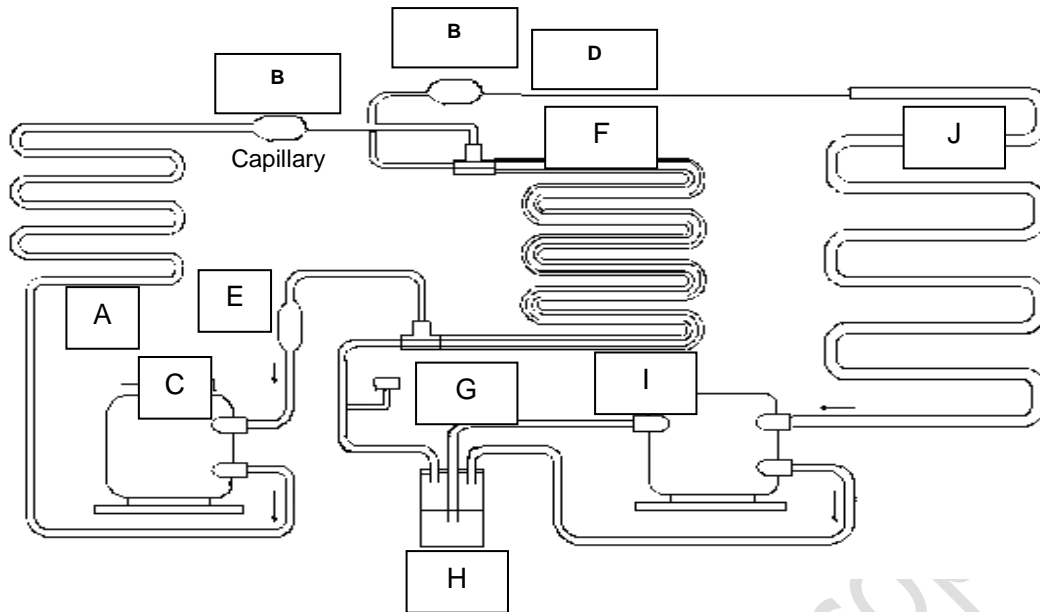

- | | |
|-------------------------------------|------------------------------|
| A -----Condenser | B -----Dry filter |
| C ----- 1st stage compressor | D -----capillary |
| E ----- Gas-liquid separator | F -----Heat exchanger |
| G ----- Pressure switch | H -----Oil separator |
| I ----- 2nd-stage compressor | J ----- Evaporator |

12. Installation & Disassembly Process

12.1 Installation Position

12.1.1. Prevented from direct sunshine

12.1.2. Good surrounding air ventilation condition

12.1.3. Prevented from a lot of dust

12.1.4. Prevented from mechanical vibration or shock

12.1.5. Ambient temperature: 5°C~28°C; maximum \leq 32°C; the most ideal temperature: 18°C~25°C; the air-conditioning system shall be used if necessary.

12.1.6. Working Position Height of the Equipment: Lower than 2000m.

12.1.7. Working humidity: <80%RH. If the maximum working temperature is 32°C, the humidity shall be lower than 57%RH.

12.1.8. Input voltage: <220±10%.

*Note: Since the ULT freezer is sensitive to the ambient temperature, it will not work normally if its installation fails to meet the above requirements.

Please use the equipment after improving the environment.

12.1.9. Battery charging principle: There is a storage battery power switch on this equipment and this

Haier Technical Document

switch shall be turned on before the freezer is switched on. As long as the switch is on, the AC equipment which meets the relevant requirement will work normally. When AC power is supplied, the equipment will charge the storage battery according to the relevant requirement. If the AC power has a failure, the storage battery will supply power to the display panel for normal supply. When the storage battery charges to the voltage $\leq 10.5V$, the battery will stop power supply and the display panel will not display. Power can be switched off thoroughly and the display panel will not display as long as you disconnect the AC power line and then switch off the equipment when the battery can supply power normally.

12.2 Product Carrying and Unpacking

12.2.1 Carrying: As the product is very heavy, a forklift or pallet jack shall be used for carrying it so as to avoid damages to people and the product.

12.2.2 Unpacking: The product package composes of a wooden pallet + EPE vertical column winding package + carton. A forklift or pallet jack shall be used to plug into the bottom of its pallet for carrying it.

See the pictures below for its package.



See *Unpacking Description* pasted inside the carton of the package. In particular, please notice that the front and back connection parts shall be removed before the pallet is lifted up.

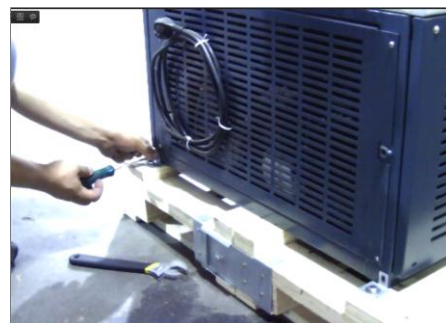

12.3 The Product Enters the Placement Room.

12.3.1 Difficulty in entering the door: If it is impossible to enter the room without the pallet because of the door height in the room where the user wants to place the refrigerator, the user can consider disassembling the front cover of the compartment and open the external door by 180°. Regarding the disassembly of the front cover of the compartment, please pay attention below:

Note: Normally, we do not suggest the disassembly of the front cover of the compartment.

12.3.2 ① Remove the two screws below the front cover of the compartment.

② Disassemble the front cover.

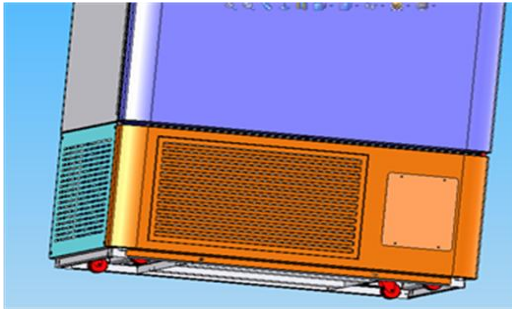

Tighten screws of the front cover of the compartment.

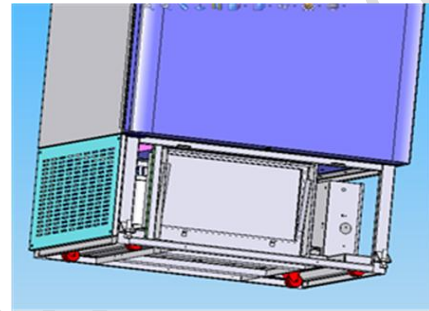

Disassemble the front cover of the compartment

③ Open the external door by 180°.

After the product enters the door, assemble the front cover of the compartment to its original condition.

Note: The front cover shall be assembled in place. Otherwise, safety and performance problems might be caused!

When the freezer is carried, its protection box shall neither be collided nor scratched, and the maximum inclination angle shall be no more than 45° (the angle with the horizontal direction), so as to avoid the refrigerating system suffers a failure and its normal use is affected.

13. Typical Troubles & Solutions and Common Q&A

13.1 Typical Troubles & Solutions

A. The displayed temperature is different from the actual testing temperature of the machine:

As our displayed temperature is at some point in the freezer but the temperature detected by the user is at another point in the freezer, surely they may be different. Furthermore, an error may exist between the testing tool of the user and our temperature probe;

B. The difference between the upper and lower temperatures in the freezer is too big:

Our machine refrigerates from top to bottom, so the temperature at the top is lower than the temperature at the bottom, the difference between the upper and lower temperatures is large, the temperature difference of similar international products is 5~8°C, and the temperature difference of our products is basically lower than 6 °C. Besides, the large difference between the upper and lower temperatures may also be caused if the door is opened and closed frequently;

C. Why is the voltage increased when the machine is started?

In order to ensure the normal operation of the machine, our machine has the voltage increase and decrease function. When the voltage of the user is lower than 183V, the machine will not be able to start. Thus, the user shall check if his circuit is normal;

Haier Technical Document

D. The user sets the temperature as -86 °C. Why does it rise to -82 °C?

In order to ensure the service life of the machine, our product will be adjusted back to -82°C if the set temperature is lower than -82°C when the ambient temperature is higher than 35°C and also return to the original set value if the ambient temperature is lower than 30°C according to the design;

E. Why does not the temperature rise quickly when the door is opened? Why does the temperature of other brands rise slowly?

(1) The temperature of the ULT freezer is low and much lower than the ambient temperature. Our probe is more sensitive, so the temperature rises more quickly when the door is opened;

(2) Computer boards and temperature probes of other brands are increased with the slower temperature return function. Therefore, the temperature rises slowly when the door is opened for the display panel display the same temperature for a long time with the temperature before the door is opened (e.g. Meiling products).

F. Why are E0 and other signs displayed?

E2 is displayed in case of the main sensor failure, E1 is displayed in case of the condenser sensor failure and E0 is displayed in case of the failure of the ambient temperature sensor. Check if the above circuits are connected correctly. If not, the after-sales service provider shall maintain or replace them.

G. How should I do if the machine moves when the door is opened?

Trundles are installed for moving, locking and supporting the machine flexibly and also realizing the slight adjustment according to the requirement. After the machine is installed in place, the front two trundles shall be fixed, so as to avoid moving the machine when the door is opened.

H. Why is it impossible to open the door of the low temperature freezer?

There are two reasons:

First, the difference between internal and external temperatures is big, which causes the door under the negative pressure. In this case, the user can use a thin sheet iron to insert into the gap between the sealing strip and the door to make air enter the freezer;

Second, goods placed by the user into the freezer contains water, which causes that water flows to the sealing strip and the door gets frozen and cannot be opened. In this case, please use a tool to open the door.

13.2 Common Q&A

Question	Reason Analysis	Maintenance Measures
1. The high temperature compressor cannot start.	1. Power switch or fuse failure	Use the multi-meter to measure the switch or fuse resistance and check if the switch is damaged. If so, replace the fuse or power switch.
	2. The plug-in part of the cabin is damaged.	Check if the plug-in joint of the cabin circuit is damaged or the harness falls down. If so, replace the relevant harness.
	3. Line contact failure	Check if the power harness is connected improperly or disconnected. If so, repair it until it is connected normally.
	4. Display panel and control panel circuit failure	Use the multi-meter to measure the circuit resistance and check if the harness has a short circuit or open circuit failure. If so, replace the harness if it is impossible to maintain it.

Haier Technical Document

	5. Relay, starting capacity or thermal protector damage	Check the relay, capacitance or heat protector/. Check if any electric part is burnt. If so, replace the electric part.
	6. Compressor failure	On condition that other parts are switched on normally, check if the connection plug of the compressor is normal. Meanwhile, observe the surface temperature and abnormal noise of the compressor. If the compressor does not heat up or the makes abnormal noise, it is damaged and shall be replaced; when it is changed, the oil separator and the dry filter shall also be changed at the same time.
	7. Too low voltage of the user	Check if the display panel voltage of the product is covered in the rated voltage scale (220V±10%). Meanwhile, use a multi-meter to measure and check if the voltage exceeds the scope when the power is switched on for operation. If the voltage is too low or too high, please prepare a stable voltage supercharger.
2. The low temperature compressor cannot start.	1. The same reason for starting failure of the high temperature compressor	On condition that other parts are switched on normally, check if the connection plug of the compressor is normal. Meanwhile, observe the surface temperature and abnormal noise of the compressor. If the compressor does not heat up or the makes abnormal noise, it is damaged and shall be replaced; when it is changed, the oil separator and the dry filter shall also be changed at the same time.
	2. Pressure switch failure	Use the multi-meter to measure the resistance of the circuit and check if the harness has a short circuit or open circuit failure. Then, replace the harness if it is impossible to maintain it.
	3. Poor refrigeration performance of high temperature compressor	If the low temperature compressor fails to start after the high temperature compressor is started for 10min., it means the high temperature compressor has poor refrigeration performance. In this case, check if the circuit and pipeline of the high temperature system are welded well (check if there is a leakage), and also troubleshoot.
3. Fan failures	1. The patch cord of the fan falls.	Check if the patch cord of the fan falls or not connected. If so, rework the thread residue and wire connection.
	2. The fan blade is blocked by foreign matters.	Check if any fan blade collides the wall, makes noise and not equipped when it rotates, troubleshoot the blade and remove surrounding foreign matters and keep the blades running normally.
	3. Fan damage	Use the multi-meter to measure the resistance at each end of the circuit of the fan and check if the spindle rotates properly. If so, replace the fan.
4. High temperature in the compartment	1. The temperature set at the shutdown point is high.	Check if the product temperature set point meets the demand of the customer. If not, reset the temperature.
	2. Refrigerant leakage	Check all welds, find leakages in the entire compartment and repair the welds. Then, refill refrigerant.
	3. Temperature probe damage	If an abnormal code alarm displays on the display panel, e.g. E0/E1/E2/E3, it means the temperature probe of the product has a failure. Meanwhile, check if patch cords

Haier Technical Document

		are connected well. If so, it means the temperature detection wire is damaged and shall be changed.
	4. The capillary or system is dirty and blocked by grease.	Open the system, clean the capillary or replace the filter.
	5. High ambient temperature	If the ambient temperature is high, please install an air-conditioner to reduce the ambient temperature.
	6. Condenser blockage	Check if the condenser is dirty and alarms. If so, please clean the filter screen in time.
5. E0 ALARM	When the input voltage of the ambient temperature sensor is $\geq 4.9V$, the sensor has an open circuit; when $\leq 0.1V$, it has a short circuit.	1. Check if the terminal of the ambient temperature sensor is plugged in improperly or falls, and if the sensor is damaged.
		2. Check if plug-in terminals of the sensor on the display panel are loose or contact poorly; and check if the display panel is damaged.
6. E1 alarm	When the input voltage of the condenser sensor is $\geq 4.9V$, the sensor has an open circuit; when $\leq 0.1V$, it has a short circuit.	1. Check terminals of the ambient temperature sensor are plugged in improperly or fall; check if the sensor is damaged.
		2. Check if plug-in terminals of the sensor on the display panel are loose or contact poorly; and check if the display panel is damaged.
7. E2 alarm	When the input voltage of the main sensor is $\geq 4.9V$, the sensor has an open circuit; when $\leq 0.1V$, it has a short circuit.	1. Check terminals of the main sensor are plugged in improperly or fall; check if the sensor is damaged.
		2. Check if plug-in terminals of the sensor on the main control panel are loose or contact poorly; and check if the main control panel is damaged.
8. E3 alarm	When the input voltage of the heat exchanger is $\geq 4.9V$, the sensor has an open circuit; when $\leq 0.1V$, it has a short circuit.	1. Check terminals of the heat exchanger sensor are plugged in improperly or fall; check if the sensor is damaged.
		2. Check if plug-in terminals of the sensor on the display panel are loose or contact poorly; and check if the display panel is damaged.
		3. Change to the backup sensor.
		4. When "E3" alarm appears, it will disappear after you press the key "Silence" for 5s. After the high temperature compressor starts for 1min., the low temperature compressor will start.
9. Hot condenser alarm	When the result of the condenser temperature detected by the condenser probe is $\geq 13\text{ }^{\circ}\text{C}$ (for 5min. constantly), an alarm happens.	1. Open the front grille and clean the filter screen.
		2. Check if the condenser probe is too close to the outlet of the condenser.
		3. Use the adhesive tape to wind the probe of the condenser.
10. Low battery capacity	When the capacity of the storage battery is $\leq 10.5V$, the low battery capacity alarm	1. Check if the storage battery expires.
		2. Check if wire terminals on the battery switch are plugged in well or if the switch is damaged.

Haier Technical Document

alarm	happens.	3. Check if the charging circuit is normal: After the freezer is switched on for 5min., check if there is voltage output from the storage battery terminal on the main control panel and also the output voltage shall be $\leq 5V$.
11. Uneven temperature in the freezer	The temperature difference in the freezer is too big.	<ol style="list-style-type: none"> <li data-bbox="756 369 1439 472">1. The temperature at the top is higher, check the door sealing strip and change the internal door to ensure the good sealing proper. <li data-bbox="756 472 1439 609">2. The temperature at the bottom is higher, open the system again and increase the low temperature refrigerant R508B (or use the needle valve to increase cold media directly)

Haier internal doc. No copying

High Temperature Alarm Solution:

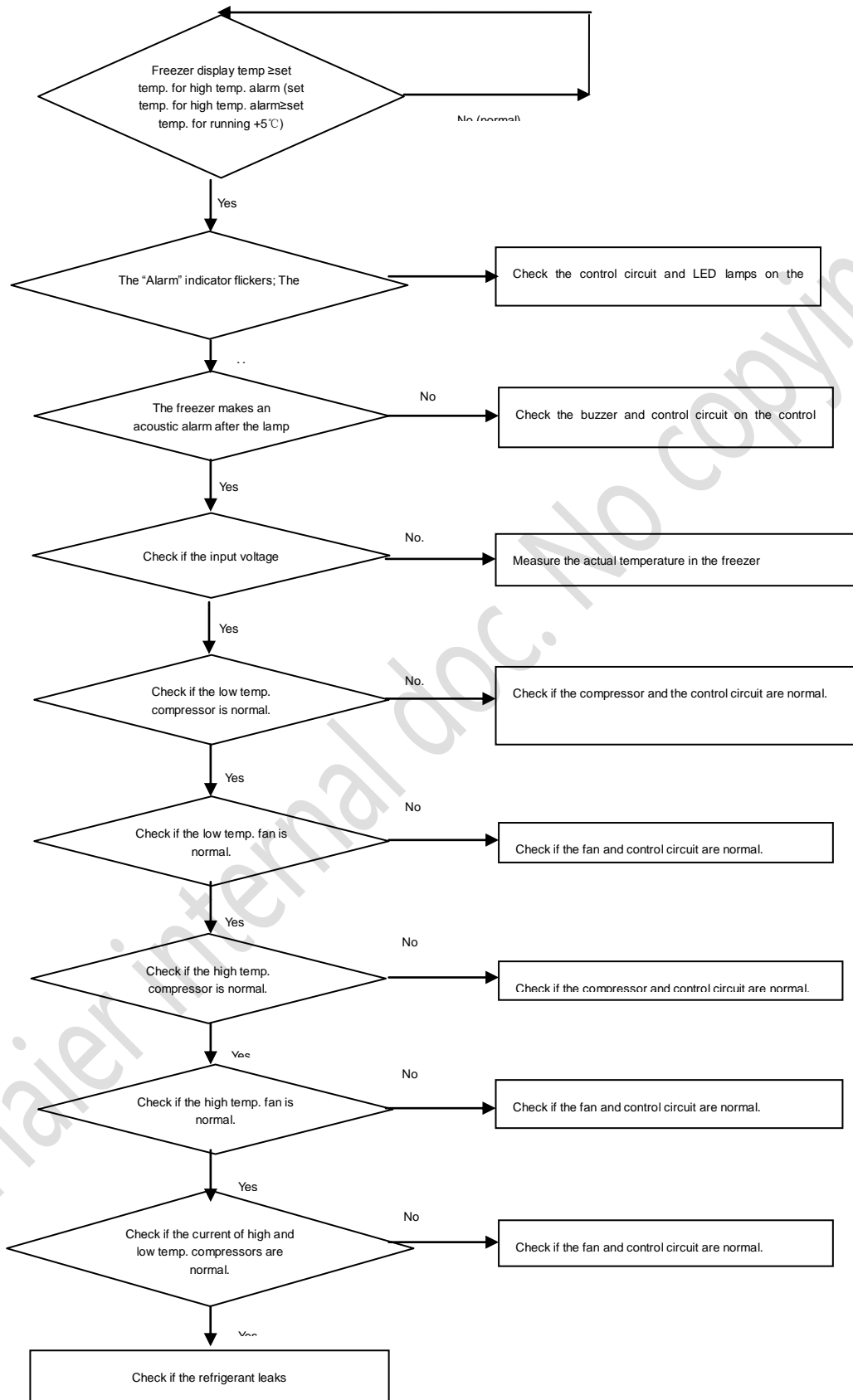

Low Temperature Alarm Solution:

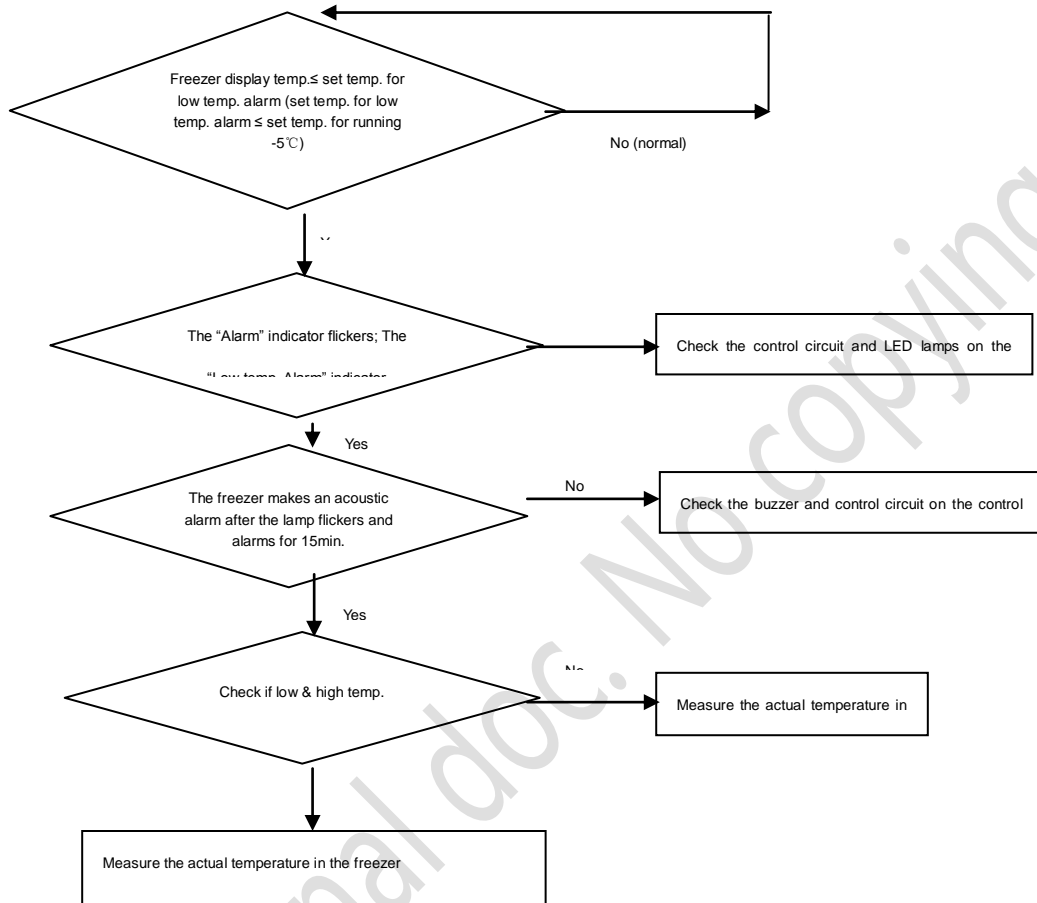

14. explosive view & spare part list

 DW-86L828J爆炸图及清单list.xlsx

 DW-86L728J爆炸图及清单list.xlsx

 DW-86L578J爆炸图及清单list.xlsx

 DW-86L490J爆炸图明细.xlsx

 DW-86L338J爆炸图及清单list.xlsx