

Haier



Deep Freezer Operation Manual

Certificate of Quality

checker:

Manufacturer: Qingdao Haier Biomedical Co., Ltd.
Address: Haier Industrial Park, Economic Technology Development
Zone, Qingdao P.R. China
Web: www.haiermedical.com
Revision Date: 09/2022
Version: 3rd, 2022
Dedicated code: 0270501299WA
V13026



Model :
DW-25L92
DW-25L262
DW-25L300
DW-30L278
DW-30L420F
DW-30L508
DW-40L92
DW-40L262
DW-40L278
DW-40L278J
DW-40L278(a)
DW-40L348
DW-40L348J
DW-40L508
DW-40L508J
DW-40L508(a)
DW-40L420F
DW-40W100
DW-40W255
DW-40W380

- Read the Operation Manual carefully before using your appliance.
- Keep the Operation Manual in a safe place.
- Appearance , color and layout of the door may vary.
- Translation of the original instruction.
- The product is fit for low temperature storing goods.



Global Warming Potential

Model	Rated voltage(VAC)	Rated frequency (Hz)	CO ₂ equivalent(Tonnes)
DW-25L92	220-240~	50	0.001
DW-25L262	220-240~	50	0.002
DW-30L420F	220-240~	50	0.002
DW-30L420F	208-230~	60	0.002
DW-30L278	220-240~	50	0.002
DW-30L508	220-240~	50	0.003
DW-40L92	220-240~	50	0.588
DW-40L92 (HC)	220-240~	50/60	0.001
DW-40L262	220-240~	50/60	0.863
DW-40L262 (HC)	220-240~	50/60	0.002
DW-40L262	115~	60	0.784
DW-40L278/278J	220-240~	50	0.002
DW-40L278(a)	220-240~	50/60	0.843
DW-40L348/348J	220-240~	50	0.003
DW-40L420F	220-240~	50	0.002
DW-40L508/508J	220-240~	50	0.003
DW-40L508	208-230~	60	0.961
DW-40L508(a)	220-240~	50	0.961
DW-40W100	220-240~	50	0.431
DW-40W100	115~	60	0.392
DW-40W255	220-240~	50/60	0.902
DW-40W380	220-240~	50/60	0.772

This product contains fluorinated greenhouse gases covered by the Kyoto Protocol. Do not vent into the atmosphere.

GWP=global warming potential

Refrigerant type	GWP
R404a	3922
R600a	20
R290	20
R23	14800

Packing List

Name	DW-25L92	DW-25L262/300	DW-40L92	DW-40L262
Manual	1	1	1	1
Calibration certificate	1	1	1	1
Plastic bag	1	1	1	1
key	/	/	/	/
Ice scraper	1	1	1	1
Drawer	3	7	3	7
Pad lock	1	/	1	/
ST4.2 screw+ M4 bolt	2+1	/	2+1	/
Handle kits	1	1	1	1
Name	DW-40L278	DW-40L278J/278(a)	DW-40L348	DW-40L348J
Manual	1	1	1	1
Calibration certificate	1	1	1	1
Plastic bag	1	1	1	1
key	4	4	8	8
Ice scraper	1	1	1	1
Drawer	6	6	12	12
Brackets (for rear wall distance)	2	2	2	2
Name	DW-40L508/508(a)	DW-40L508J	DW-30L278	DW-30L508
Manual	1	1	1	1
Calibration certificate	1	1	1	1
Plastic bag	1	1	1	1
key	8	8	2	/
Ice scraper	1	1	1	1
Drawer	10	10	6	10
Brackets (for rear wall distance)	2	2	2	2
ST4.2 screw	/	/	2	2
Handle kits	/	/	1	2
Name	DW-30L420F DW-40L420F	DW-40W100	DW-40W255	DW-40W380
Manual	1	1	1	1
Calibration certificate	1	1	1	1
Plastic bag	1	1	1	1
key	4	2	2	2
Ice scraper	1	1	1	1
Shelf / drawer	5/6(Optional)	/	/	/
Storage basket	25(Optional)	1	2	6

The product herein is mainly used for custody of frozen plasma, bio-materials, vaccine, and low-temperature test for electron devices and special materials, which is applicable to blood stations, hospitals, epidemic stations, colleges and universities, scientific research institutes, and electronic chemical laboratories and other enterprise laboratories.

Temperature control

Structure and parts: the Product could be sorted as top-open type and vertical type by the form of its door or cover, which could prepare a storage environment with the temperature range from -10°C to 40°C. It is computer-based control and displays temperature in digital with the accuracy of 0.1°C / 1°C, and for the temperature range displayed on computer board, the Series 25 is from -10°C ~ -25°C, the Series 30 is from -10°C ~ -30°C, the Series 40 is from -20°C ~ -40°C, all of which could be adjustable.

Safety system

- Multiple fault alarms (hi-low temperature alarm, low battery power alarm, power failure alarm, sensor error alarm, door ajar alarm, high ambient temperature alarm)
- Two modes for alarms (sound buzzer and alarm lamp flickering) which can be connected with remote alarm
- All independent parts have safe earthing

Refrigeration system

With deeply-optimized refrigerating system and compressor and main parts of famous brand, it could be performed better in refrigeration, and it could be widely applicable to keep materials under low-temperature condition for such departments as clinics, medicine, scientific research, and inspection and quarantine.

User-friendly Design

- User-friendly Design of computer control mode, intelligence without anxiety, adjustment free
- High performance insulation layer with better thermal insulation effect
- People-based design such as safety door latch
- Function of inquiring alarm history (DW-30/40L420F only)

The characteristics above mentioned are not all equipped for all types of products, for details, refer to the specification list of each type.

The deep freezer you obtained is probably not exactly the same as illustrated in the instruction due to continuous improvement of product, we regret for this. Content of this manual is subject to alternation without further notice.

Product Feature.....	1
Content.....	2
Safety Precautions	3
Application guidelines.....	6
Product installation	7
Name of parts • Control panel	13
Application method.....	19
Alarm	33
Cleaning maintenance.....	37
Rechargeable battery recycling.....	39
FAQ	40
Refrigeration Schematic & Circuit Diagram.....	42
Circuit Diagram.....	46
Specification	50

Specification

Name	Deep Freezer							
Model	DW-40W100		DW-40W255		DW-40W380			
Exterior dimensions (W × D × H) (mm)	685×650×810		1243×724×838		1554×724×838			
Interior dimensions (W × D × H) (mm)	500×385×630		1036×426×625		1375×453×640			
Effective volume	100L		255L		380L			
Door	Solid door							
Insulation	CFC-Free foamed-in-place urethane							
Compressor	High Quality Hermetically sealed compressor							
Basket / loading of each	1 / max:10kg		2 / max:10kg		6 / max:10kg			
Refrigeration	Direct cooling							
Exterior / Interior	Spraying steel plate / aluminium plate with flax texture							
Condenser/Evaporator	Wire and tube type / coil tube type							
Temperature control	Microprocessor controlled							
Refrigerant	R404a 110g		R404a 100g		R404a 230g		Mix refrigerant 162g	
Weight	43kg		70kg		82kg			
Temperature range	-20℃ ~-40℃		-20℃ ~-40℃		-20℃ ~-40℃			
Voltage	220-240V~/50Hz		115V~/60Hz		220-240V~/50Hz/60Hz		220-240V~/50Hz/60Hz	
Rated power/current	260W/2.5A		255W/5.0A		410W/2.5A		550W/3.4A	
Noise Level	35dB(A)		41dB(A)		45dB(A)			
Foaming Agent	HFO-1233zde							
Climate Type	SN N							
Type of protection against electric shock	I							
Test holes	1				/			
Alarms	High/low temperature alarm, sensor error alarm and power failure alarm							
Duration time of power outage alarm	20 hours (when battery is fully charged)							

Note: Technical information may vary from the appliance that you have just purchased due to technical improvements.

Safety Precautions

Specification











Name	Deep Freezer	
Model	DW-30L420F/DW-40L420F	
Exterior dimensions(W × D × H) (mm)	950×890×1900	
Interior dimensions (W × D × H)(mm)	685×610×1028	
Effective volume	420L	
Door	Solid door	
Insulation	CFC-Free foamed-in-place urethane	
Compressor	High Quality Hermetically sealed compressor	
shelves / Baskets/Drawers	5 / 25(Optional)/6(Optional) the loading of each shelf: max 36kg	
Refrigeration	Positive, forced-air circulation	
Exterior / Interior	Spraying steel plate / stainless steel	
Condenser/Evaporator	Wire and tube type	
Temperature control	Microprocessor controlled	
Refrigerant	R290 95g	
Weight	195kg	
Temperature range	-10℃ ~-30℃ /-10℃ ~-40℃	
Voltage	220-240V~/50Hz	208-230V~/60Hz
Rated power/current	460W/4.0A	
Defrost power / current	1000W/5.8A	
Noise Level	46dB(A)	
Foaming Agent	HFO-1233zde	
Climate Type	SN N	
Type of protection against electric shock	I	
Test holes	1	
Alarms	High/low temperature alarm, sensor error alarm, power failure alarm, high ambient temperature alarm,low battery alarm, door ajar alarm and historical alarm queries	
Duration time of power outage alarm	48 hours (when battery is fully charged)	
Rechargeable battery	DC 12 V rechargeable battery	

Note: Technical information may vary from the appliance that you have just purchased due to technical improvements.





Dear Customers,

Thank you for choosing Haier deep freezer. Please make sure that you have carefully read the manual and follow the instruction as outlined. This is to prevent personal injury and damage to products.





Safety labels

 The upper and lower limits of temperature shall be indicated adjacent to the upper and lower horizontal lines.	 Symbol for "Manufacture"	 No sitting	 Grounding mark	 R290
 Symbol for "Consult instructions for use"	 Symbol for "Date of manufacture"			
 EC REP European Authorized Representative	Shanghai International Holding Corp. GmbH(Europe) Eiffestr. 80, 20537 Hamburg, Germany			
When power to the unit is on, switch on the battery charger. When the unit is not in use switch power off and then switch off the battery charger..			 CE 0197	Complied with the requirements of MDD 93/42/EEC annex V
NOTICE! 1.Freezer must be placed at least 20mm away from the wall to allow maximum air circulation. 2.Changing of Refrigerants should be done according to the Service Manual.			 WARNING! ELECTRIC CABINET CONTAINS CONTROL PANEL CONTACTOR ETC.	

Safety precautions

-  **Warning** Ignoring this warning may result in death or serious injury
-  **Caution** Ignoring this warning may result in death or serious injury, and/or damage to the freezer and property
-  Actions or operations which are prohibited
-  Actions or operations which must be followed

Warning

-  When there is a leak of flammable gas, shutoff the feed valve of the gas. Open windows for ventilation and exhaust. Do not plug in your freezer or unplug your freezer as spark in these processes can cause an explosion or fire.
-  We recommend the unit be installed and maintained by a professional to avoid any electrical hazard.
-  Place the freezer on solid and flat ground to avoid tipping the unit over to cause personal injury.
-  Only connect the freezer unit with a dedicated power outlet specified by the nameplate of the unit. This is to avoid fire or electric shock.

- ⚠ If the supply voltage is lower or higher than the rated voltage, an automatic voltage regulator of at least 2,000W should be installed with the refrigerator.
- ⚠ If the power cord needs to be lengthen, the cross section area of the extension line's conductor should be at least 2 mm² and the length of the extension cord should be limited to 3m. This is to prevent electric fire or shock.
- ⚠ The power cord of this freezer is provided with a three-wire (earthing) plug, complying with the standard 10A three-wire (earthing) socket. Never cut or remove the earthing pin of the power cord in any case. Make sure that the power plug and socket is inserted tightly and reliably, otherwise it may result in a fire.
- ⚠ Please use an earthed power supply socket for fear of electric shock. If the power socket is not earthed, be sure to have the earth wire installed by a professional technician.
- ⊘ Do not use the freezer in the open air. When the freezer gets wet in the rainwater, it may cause leakage of electricity or electric shock.
- ⊘ Do not place the freezer in a damp site or a place where it may easily suffer from spraying water. Otherwise, it may cause leakage of electricity or electric shock due to degeneration of its insulation.
- ⊘ Do not pour water onto the freezer in a direct inclined way, otherwise it may cause an electric shock or a short circuit.
- ⊘ Do not place any vessel containing water or any heavy object on the freezer. If the object drops off, it may cause personal injury and the flowing water will degenerate the insulation and further cause leakage of electricity or electric shock.
- ⊘ Do not make the freezer earthed via a gas-pipe, power supply conduit, telephone line or lightning rod. The above earthing will cause an electric shock or other dangers.
- ⊘ Do not contact any electric parts or any switches such as power plug and so forth with a wet hand, or otherwise it may cause an electric shock.
- ⚠ When pulling out a plug from the power socket, hold the power plug firmly but do not pull the wire of the power plug. Pulling the wire with hand may cause an electric shock or lead to a fire due to short circuit.
- ⚠ If the freezer runs out of order, please pull out the power plug. Continuous running in an abnormal condition may cause an electric shock or fire.
- ⊘ User must not dismantle, repair or refit the freezer by itself. Otherwise, it may cause a fire or personal injury due to improper operation.
- ⚠ Before conducting any repair or maintenance of the freezer, be sure to disconnect the power of the freezer for fear of electric shock or personal injury.
- ⚠ Make sure not to suck in medicine or suspended particles inside and surrounding the freezer in time of repair and maintenance, otherwise, it may bring hurt to your health.
- ⚠ When storing toxic, hazardous or radioactive articles, please use the freezer in a safety zone. Improper use may bring hurt to human health or environment.
- ⚠ Pull out the power plug when the freezer is not in service for a long time so as to prevent electric shock, leakage of electricity or fire due to aging of the power cord.
- ⚠ If the freezer is left unused for a long time in an unattended area, make sure that children will not approach the freezer and the freezer door will not be closed completely.

Specification

Name	Deep Freezer	
Model	DW-30L278	DW-30L508
Exterior dimensions (W × D × H) (mm)	745×675×1810	915×810×1860
Interior dimensions (W × D × H)(mm)	520×435×1230	685×610×1228
Effective volume	278L	490L
Door	Solid door	
Insulation	CFC-Free foamed-in-place urethane	
Compressor	High Quality Hermetically sealed compressor	
Drawers	6	10
Refrigeration	Direct cooling	
Exterior / Interior	Spraying steel plate / PS plate	
Condenser/Evaporator	Wire and tube type/Plate type	
Temperature control	Microprocessor controlled	
Refrigerant	R290 105g	R290 150g
Weight	115kg	164kg
Temperature range	-10°C ~-30°C	-10°C ~-30°C
Voltage	220-240V~/50Hz	220-240V~/50Hz
Rated power/current	330W/2A	530W/3A
Noise Level	40dB(A)	41dB(A)
Foaming Agent	HFO-1233zde	
Climate Type	SN N	
Type of protection against electric shock	I	
Test holes	1	
Alarms	High/low temperature alarm, sensor error alarm, power failure alarm, and alarm for exceeding upper and bottom thresholds of temperature	
Duration time of power outage alarm	24 hours (when battery is fully charged)	

Note: Technical information may vary from the appliance that you have just purchased due to technical improvements.

Specification

Name	Deep Freezer					
Model	DW-40L278/278J	DW-40L278(a)	DW-40L348/348J	DW-40L508/508J		DW-40L508(a)
Exterior dimensions (W × D × H) (mm)	770x710x1810		790x845x1860	940x845x1860		
Interior dimensions (W × D × H) (mm)	520×435×1230		535×610×1228	685×610×1228		
Effective volume	278L		348L	490L		
Door	Solid door					
Insulation	CFC-Free foamed-in-place urethane					
Compressor	High Quality Hermetically sealed compressor					
Drawers	6		12	10		
Refrigeration	Direct cooling					
Exterior / Interior	Spraying steel plate / PS plate					
Condenser/ Evaporator	Wire and tube type					
Temperature control	Microprocessor controlled					
Refrigerant	R290 90g	R404a 215g	R290 140g	R290 145g	R404a 245g	R404a 245g
Weight	115kg		137kg	164kg		
Temperature range	-20℃ ~-40℃		-20℃ ~-40℃	-20℃ ~-40℃		
Voltage	220-240V~/50/60Hz	220-240V~/50/60Hz	220-240V~/50Hz	220-240V~/50Hz	208-230V~/60Hz	220-240V~/50Hz
Rated power/ current	275W/2.9A	370W/5.1A	280W/2.9A	285W/2.9A	510W/5.6A	510W/5.6A
Noise Level	40dB(A)	44dB(A)	41dB(A)	41dB(A)	45dB(A)	45dB(A)
Foaming Agent	HFO-1233zde					
Type of protection against electric shock	I					
Test holes	1					
Alarms	High/low temperature alarm, sensor error alarm, power failure alarm, low battery alarm, high ambient temperature alarm and door ajar alarm (only applicable to DW-40L278/278J/278(a))					
Duration time of power outage alarm	48 hours (when battery is fully charged)					
Rechargeable battery	DC 12 V rechargeable battery					

Note: Technical information may vary from the appliance that you have just purchased due to technical improvements.

- ! Disposal of discarded freezer shall be conducted by the relevant personnel. Dismantle the door to prevent occurrence of accidents such as suffocation.
- ⊘ Do not set off hazardous articles that are inflammable, explosive or volatilizable in the freezer, nor use the flammable spraying agent in the vicinity of the freezer, or otherwise, it may trigger an explosion or fire.
- ⊘ Do not store corrosive articles such as acid, alkali etc. in the freezer. Otherwise, it may spoil the internal units or electric parts of the freezer.
- ⊘ Do not place the packing plastic bags at the locations where children can easily take as plastic bags may cause occurrence of suffocation accident.
- ⊘ Do not climb up to the freezer or place articles on the freezer, otherwise it may cause personal injury or damage of freezer due to overturn of the freezer.
- ⊘ Do not insert any metal objects like iron nails, iron-wire into any orifice and gap or any air vent used for internal air circulation of the freezer, otherwise, it may cause an electric shock or injury due to contact of the above objects with the moving parts.

Caution

- ! When restarting the freezer after a power failure or power-off, it is required to check the setting of the freezer. Change of setting may spoil the articles stored.
- ! Once the power of the freezer is cut off, wait for over 5 minutes before it is reconnected so as not to damage the compressor or the system.
- ! Put on your gloves at time of maintenance so as not to bump the sharp edges or corners, resulting in personal injury.
- ! Close the door of the freezer with your hand holding the handle so that your fingers will not be pinched by the door.
- ! The inclination angle shall be no greater than 45 ° when handling the freezer.
- ⊘ When handling the freezer, be careful not to trip over it, preventing personal injury or damage to the freezer.
- ⊘ Do not pull or carry the equipment by the door handle, preventing damage to the freezer or personal injury.
- ! There shall be no obstacles around the freezer, and keep it well-ventilated and clear.
- ⊘ Do not spoil the refrigerating circuit.
- ⊘ Do not use any electric appliance in the store-room of the freezer except for the types that the manufacturer recommended for use.
- ! The product placement distance from the wall shall not be greater than 20mm.

Application guidelines

During the normal process of use, please read the following precautions seriously before use, in order to keep the low-temperature freezer in the best performance:

- About the battery

Some types of this series of low-temperature freezer is equipped with built-in rechargeable batteries, which could send alarm message about outage to you immediately when the power is off, so as to protect your storage to the largest extent. In addition, you should understand and pay attention to points as follows about the batteries:

a. Type DW-25L92/262/300 and DW-40L92/262 are not equipped with rechargeable batteries, so they could not send any alarm message for outage;

b. The controllers of DW-30L278/508 and DW-40W100/255/380 are respectively equipped with a rechargeable battery, which is irreplaceable and could not be controlled by any switch. Under normal condition, such battery could be fully recharged within about 24 hours, which could under normal work for outage alarm and display for 18 hours. Therefore, if the power of this series of product is off for more than 24 hours, the battery would be no power, and then the function of alarming for outage would become invalid;

c. Type DW-40L278/278J/278(a)348/348J/508/508J/508(a)420F/30L420F is respectively equipped with a replaceable rechargeable battery, which is located within the electric cabinet. In addition, a battery switch is equipped in it, too, so that when the power of product is scheduled to be off or would be not used for a long time, you should unplug the power cable and turn the switch to "O" timely, in order to prolong the service life; when it is planned to use the product under normal condition, you should turn the switch to "I" in order to keep the alarm for outage normal.

- Storage and withdrawal of stored articles

a. Before putting any article in the freezer, you should confirm that whether the storage temperature of article complies with the setting temperature of the freezer in advance;

b. Before putting any article in the freezer, you should confirm that whether the temperature within the freezer has already reached to the setting temperature in advance;

c. When putting in the articles, you should put them successively in batches, and the volume of article to be put each time could not be larger than 1/3 of volume of the freezer, in order not to make the refrigerating system overloaded;

d. When putting or taking the articles each time, please minimize the time for door closing, in order to reduce the energy consumption and keep the temperature within the freezer relatively stable;

- Lock latch of vertical-type freezer

The lock latch of vertical-type freezer should be fastened after the freezer is electrified for use, otherwise the temperature would become higher and frosting would become serious, and the normal use would be affected.

- Test hole of freezer

The test hole equipped on the wall of freezer is a through-hole, which is used to lead out the measuring line within the freezer during test. After leading out the measuring line, please stuff the test hole with heat insulating materials again, otherwise the temperature within the freezer would stay high, and dew or frost would be condensed surrounding to the outside of through-hole.



Meaning of crossed –out wheeled dustbin:

Do not dispose of electrical appliances as unsorted municipal waste, use separate collection facilities. Contact you local government for information regarding the collection systems available. If electrical appliances are disposed of in landfills or dumps, hazardous substances can leak into the groundwater and get into the food chain, damaging your health and well-being.

Specification

Name	Deep Freezer			
Model	DW-25L262	DW-40L262		
Exterior dimensions (W × D × H) (mm)	700×705×1665			
Interior dimensions (W × D × H) (mm)	480×465×1430			
Effective volume	262L	262L		
Door	Solid door			
Insulation	CFC-Free foamed-in-place urethane			
Compressor	High Quality Hermetically sealed compressor			
Drawers	7			
Refrigeration	Direct cooling			
Exterior / Interior	Spraying steel plate / PS plate			
Condenser/Evaporator	Wire and tube type			
Temperature control	Microprocessor controlled			
Refrigerant	R600a 90g	R404a 220g	R290 75g	R404a 200g
Weight	88kg	88kg		
Temperature range	-10℃ ~-25℃	-20℃ ~-40℃		
Voltage	220-240V~/50/60Hz	220-240V~/50/60Hz		115V~/60Hz
Rated power/current	165W/0.96A	400W/4.8A	350W/2.2A	600W/7.5A
Noise Level	34dB(A)	44dB(A)	38dB(A)/41dB(A) (50Hz/60Hz)	44dB(A)
Foaming Agent	HFO-1233zde			
Type of protection against electric shock	I			
Test holes	1			
Alarms	High/low temperature alarm, sensor error alarm			

Note: Technical information may vary from the appliance that you have just purchased due to technical improvements.

Specification

Name	Deep Freezer			
Model	DW-25L92	DW-40L92	DW-25L300	
Exterior dimensions (W × D × H) (mm)	640×610×860		700×705×1665	
Interior dimensions (W × D × H) (mm)	435×410×635		480×465×1430	
Effective volume	92L		300L	
Door	Solid door			
Insulation	CFC-Free foamed-in-place urethane			
Compressor	High Quality Hermetically sealed compressor			
Drawers	3		7	
Refrigeration	Direct cooling			
Exterior / Interior	Spraying steel plate / PS plate			
Condenser/Evaporator	Wire and tube type			
Temperature control	Microprocessor controlled			
Refrigerant	R600a 52g	R290 40g	R404a 150g	R600a 90g
Weight	46kg	46kg		88kg
Temperature range	-10℃ ~-25℃	-20℃ ~-40℃		-10℃ ~-25℃
Voltage	220-240V~ /50Hz	220-240V~ /50/60Hz	220-240V~ /50Hz	220-240V~/50Hz
Rated power/current	160W/0.68A	330W/2.0A	220W/2.1A	165W/0.96A
Noise Level	27dB(A)	29dB(A)	40dB(A)	34dB(A)
Foaming Agent	HFO-1233zde			
Climate Type	SN N			
Type of protection against electric shock	I			
Test holes	1			
Alarms	High/low temperature alarm, sensor error alarm			

Note: Technical information may vary from the appliance that you have just purchased due to technical improvements.

Installation environment

- Ambient temperature: 10℃ to 32℃ , with maximum beyond 32℃ , the optimal temperature is 18℃ to 25℃ , the air conditioning system shall be used when necessary.
- Ambient humidity: below 85% Rh.
- Avoid large quantities of dust.
- Avoid mechanical sway or vibration.
- The altitude of freezer's working position: lower than 2000m.
- Input voltage: the rated voltage ±10%.
- Keep away from the radiated area and avoid the use of radiation-sensitive devices at its periphery.
- Pollution Degree: 2; indoor use.
- The transient state is Category II facility (overvoltage category).

Caution

- As the freezer is sensitive to the environmental temperature. The freezer cannot operate normally if it is installed in an environment other than the above. Please use it after improving the environment.
- It is prohibited to install the freezer in the open air environment. When the freezer gets wet in the rainwater, it may cause leakage of electricity or electric shock accident.

Installation place

For normal operation and optimum performance level of the freezer, its installation place shall conform to the following conditions:

- It can not be installed in a narrow, small and airtight space, the door frame of the room for placing it shall not be less than and lower than this product, and shall at least guarantee its normal passing in and out so as to avoid any maintenance difficulty and failure of in-time repair in occurrence of machine fault, causing spoilage to the stored articles.
- The ground at the installation place shall be solid and flat.
- It shall be well-ventilated without direct sunshine.
- Do not share a socket with other equipment, the plug and socket shall be well connected.
- Do not distort or stress the power cord.
- If it is required to lengthen the power cord, the section area of the lengthened wire shall not be less than 3mm² and the length shall not be longer than 3m.
- Check the operating voltage before use, at the area where the voltage is not stable, use of a voltage regulator suitable for the motor load shall be considered for voltage stabilization. So that the normal input voltage is stabilized at the rated voltage ±10%, the power of the voltage regulator is greater than 2000W.
- The freezer shall be guaranteed with reliable earthing.
- If the power socket has earth wire, check if the earthing is good before use.
- If the socket is not furnished with an earth wire, be sure to install one by the professional engineering and technical personnel.

Warning

- Do not make freezer earthing via gas piping, water supply pipe, telephone line or lightning rod that may easily cause an electric shock.
- After installation, the power plug must be accessible to facilitate unplugging of the power cord in emergency. No articles shall block out the air vent of the freezer.

Preparation before Use

1. Disassemble all packaging materials, including the base

Take out all packaging materials of product at suitable site, including the base, and disassemble all fixed tapes or other fixtures on the freezer used for transportation safety.



- For Type DW-40L278/278J/278(a)/348/348J/508/508J/508(a)/420F and DW-30L278/420F/508, fixed links are respectively equipped on both sides and the base of the freezer, so that the link on the base should be removed before the base is taken down;
- Please select appropriate site for disassembling the package. For Type DW-25L92/262/300, DW-40L92/262/278/278J/278(a)/348/348J/508/508J/508(a)/420F, and DW-30L278/420F/508, the attached trundles could move the freezer to appropriate site after the package is disassembled; for the horizontal type product, there is no trundle equipped at the base of the freezer, so please move the freezer to the proper site before disassembling the package;
- For the freezer packed well, it could be moved by forklift or clipping vehicle; if you use the forklift, please insert the forks under the wooden base of the front or back side of the freezer when there is a wooden base equipped in the freezer; otherwise, if there is no wooden base, please slightly incline the freezer (with the inclination no more than 45°), and then insert the fork between the seam; if you use the clipping vehicle, you should clip the freezer together with the base, and should only clip the sides of the freezer.

2. Check the accessories shipped with the equipment

Please check the articles inside the bin as per the packing slip, contact the after-sale service in time in case of any discrepancy.

3. Install the Clearance holder

For DW-40L278/278J/278(a)/348/348J/508/508J/508(a) and DW-30L278/508, two Ω-shaped holder kits are attached, and you could use the attached screws to fix the Ω-shaped holder on the screw holes at the back within the freezer.

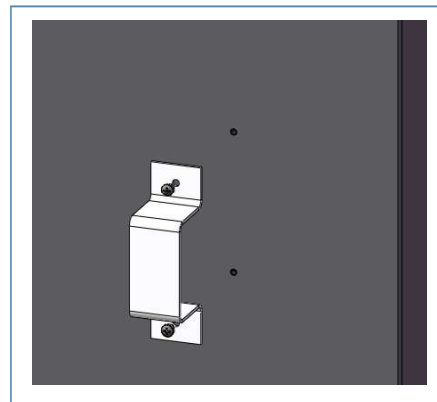

for vertical type and DW-30L278/508)

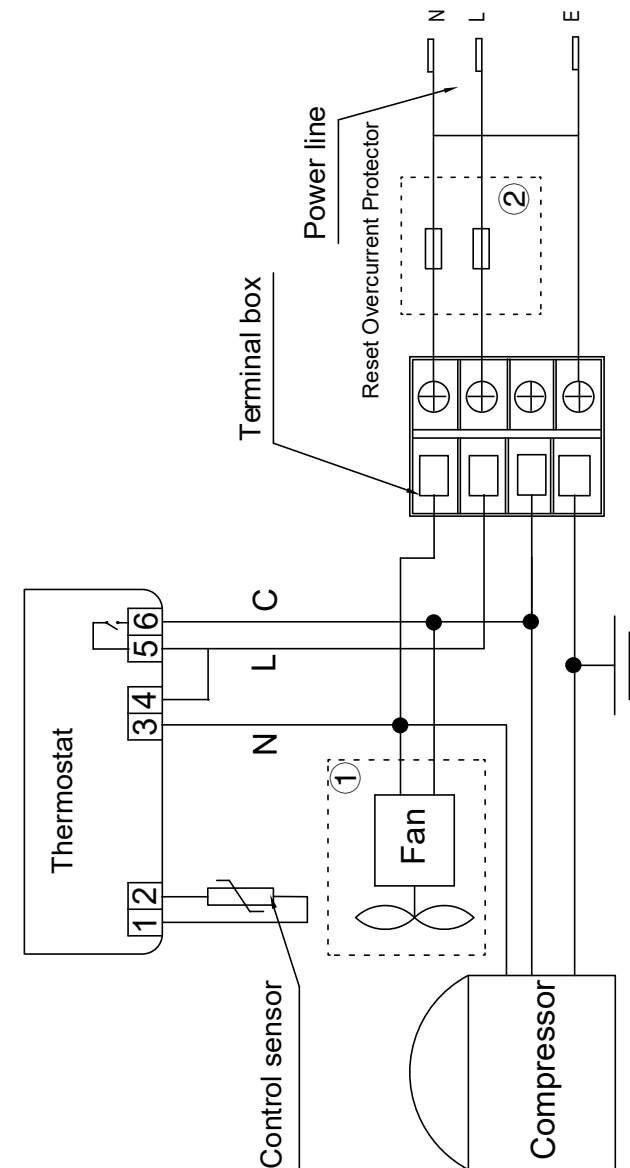

Remarks:
 1. The fan in the dashed box ① is not applicable to DW-25W198 model;
 2. The Reset Overcurrent Protector in the dashed box ② is only applicable to DW-30L278/508 model

DW-30/40L420F

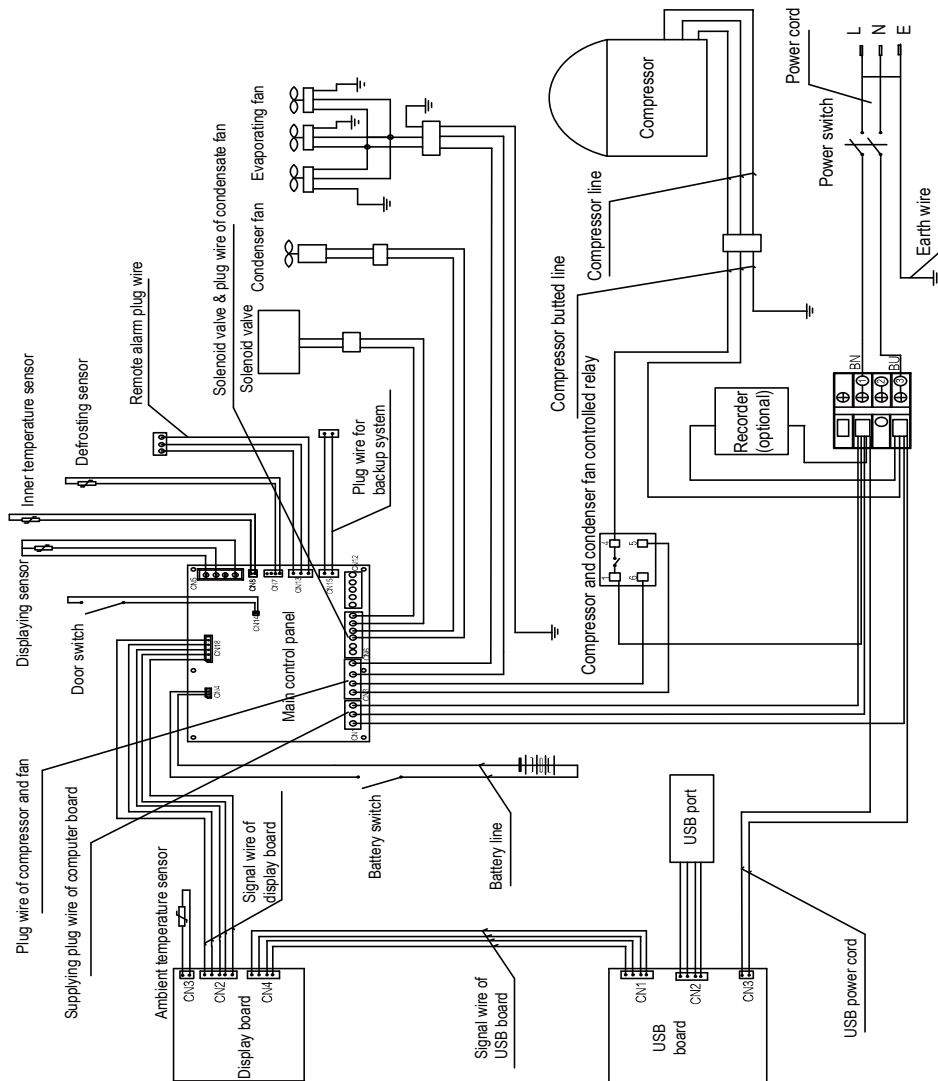

4. Install side lock latch

For Type DW-25L92 and DW-40L92, the attached lock latch kit should be taken out and then installed on the left side of freezer according to the "Lock Catch Installation Instruction Leaflet" stipulated in the Appendix.

5. Installing the door handle

• DW-25L92/262/300 and DW-40L92/262

- a. Align the handle with the screw hole on the door as shown;
- b. Fix the handle with screws.

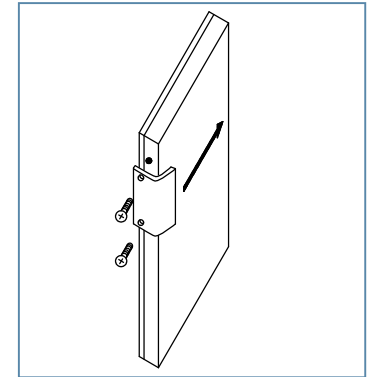

• DW- 30L278/508

- a. Place the side of handle with hole downwards;
- b. Align the handle with its holder;
- c. Fix the holder and the handle and then lift up the handle;
- d. Fix the handle with screws from the bottom after the handle is fastened.

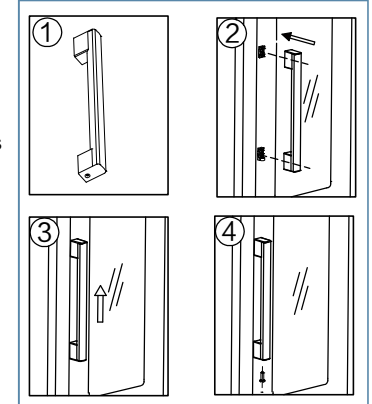

6. Select appropriate site for placement

In order to keep the freezer under appropriate condition for ventilation, please place it according to the requirements as follows:

- a. 30cm distance should be kept surrounding to the vertical freezer as well as the top of it;
- b. For the horizontal freezer, besides 30cm distance kept surrounding to it, 60cm should be kept apart from its top so as to close the door normally;
- c. In order to keep the operation stable, please keep the placing site flat and solid.

7. Leveling of the unit

At the bottom of the upright freezer, there is a leveling leg that allows an adjustment of one of the corners of the unit to secure its placement. Turn the leveling leg accordingly to adjust the height.

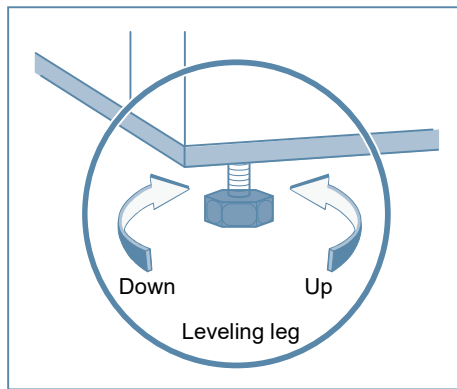

8. Leave the unit stand before powering up

Do not turn on the unit immediately after it is situated on site. Keep the unit standing for 24 hours before powering up the unit.

Caution

- To handle the freezer before unpackaging, forklift or package carrier may be used. If the forklift is used, it shall be inserted at the bottom of blocking from the front or back of the freezer to move the freezer. If the package carrier is used, it shall pick up at the bottom of blocking and can only pick up the side of the freezer.
- After unpackaging, to handle the freezer, you may push wheels for handling.
- During handling, the inclination angle of freezer shall not be greater than 45°.

DW-40L278/278J/278(a)/348/348J/508/508J/508(a)

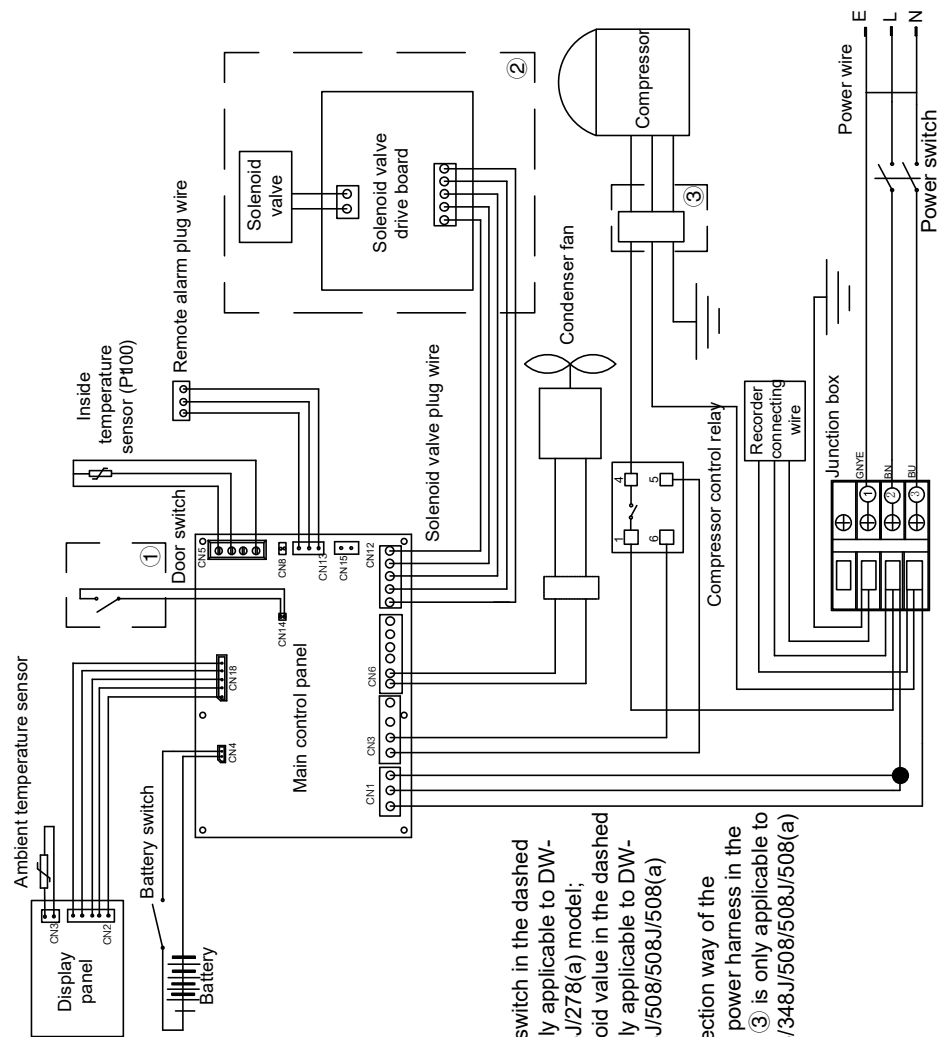

Remarks:

1. The door switch in the dashed box ① is only applicable to DW-40L278/278J/278(a) model;
2. The solenoid valve in the dashed box ② is only applicable to DW-40L348/348J/508/508J/508(a) model;
3. The connection way of the compressor power harness in the dashed box ③ is only applicable to DW-40L348/348J/508/508J/508(a) model;

Circuit Diagram

DW-25L92/262/300 and DW-40L92/262

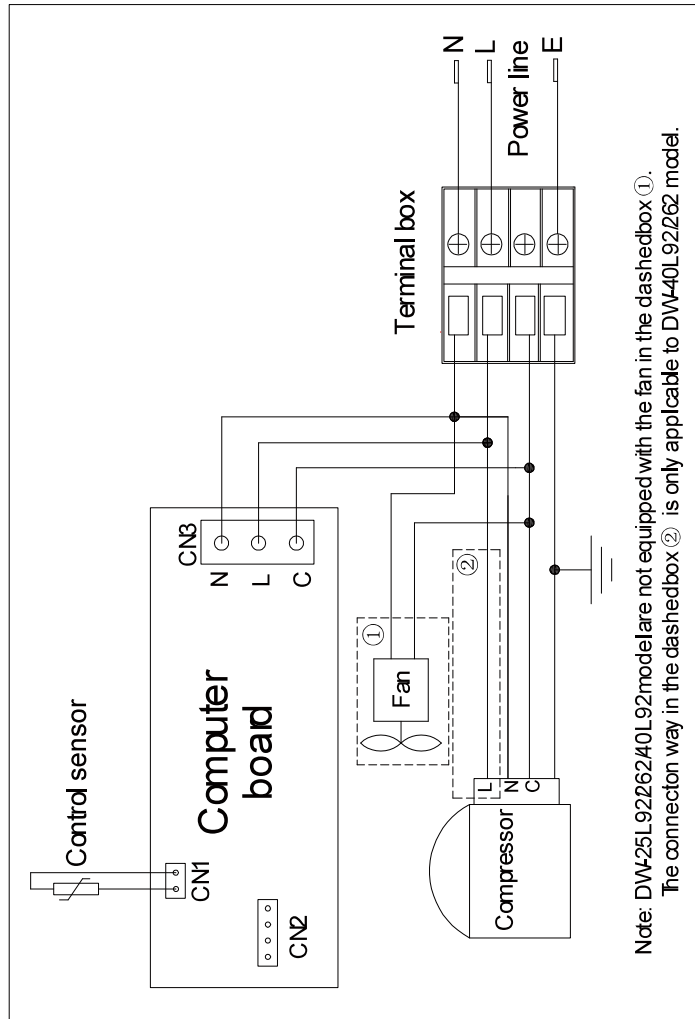

Initial power-on

Please observe the following rules when conducting initial start-up and continuous running:

Keep the unit empty; connect the unit to a dedicated power socket that meets the power requirement of the freezer.

After power up, turn on the battery switch of the units to charge the battery. The audible alarm may sound and this is normal. Press the Silence button (for DW- 25L92/262/300 and DW-40L92/262, press alarm button; for horizontal type and DW- 30L278/508, press any button) to cancel the alarm on.

Power on, and set the temperature required without putting any article in the empty freezer, and then observe that whether the freezer could be turned on or off under normal condition for over 24 hours, in order to confirm that the performance of freezer is normal.

Start putting articles gradually into the freezer after completing a thorough inspection of the freezer.

- A person shall be specially assigned for daily check and record of the product operating conditions, in case the temperature inside the bin is on the high side or on the low side, just transfer the articles to the other freezers till the fault is removed and then replace back the articles.
- Before putting any article in the freezer, please confirm that the temperature required for the article is consistent with the temperature range of this product in advance, in order not to damage the article due to the failure of this product to reach to the temperature required for the article.
- The indicated temperature of this product may have a certain difference with the actual temperature inside the bins due to refrigeration inertia, this is normal.
- The temperature within the topside drawer of freezer would be relatively higher than that in other drawers, so, for any article with strict requirements for temperature should be placed in other drawers as possible.



Caution For Type DW-40, if its temperature is set to be high (such as higher than -25°C), the temperature deviation might become more serious due to the refrigeration inertia, which would be more serious when the temperature is set to be higher. Therefore, it is suggested that Type DW-40 should be used under -30°C , and for any service temperature that is higher than -25°C / -30°C , please select Type DW-25/30.

- All the freezers are of storage equipment, and it is strictly forbidden to put excessive articles that are relatively too hot in one go, this will cause long time of running of the compressor without stop, slow drop of temperature, thus affecting service life of the compressor, the articles must be put in batches so that the temperature drops in steps till the required temperature is reached.
- Do not use any mechanic tool or other means without permit from manufacturer to accelerate the process of defrosting.
- Do not spoil the refrigerating circuit.
- Inside the freezer, do not use the electric appliance without production permission.

Operation after a power failure

The freezers can retain their operation parameters when there is power outage. When the power recovers, they will continue to operate based on the saved parameters.



- Under outage or other fault, the freezer would stop and the inner temperature will rise. If the power could not be recovered in a short time, please take out the articles and store them by other means, in order to avoid any loss caused by article damage.
- Once the power of the freezer is cut off, wait for over 5 minutes before it is reconnected so as not to damage the compressor or the system.
- Pull out the power plug when the freezer is not in service for a long time and turn off the battery switch if applicable, so as to prevent electric shock, leakage of electricity or fire due to aging of the power cord.
- If the freezer is left unused for a long time in an unattended area, make sure that children will not approach the freezer and the freezer door can not be closed completely.

others are for horizontal type

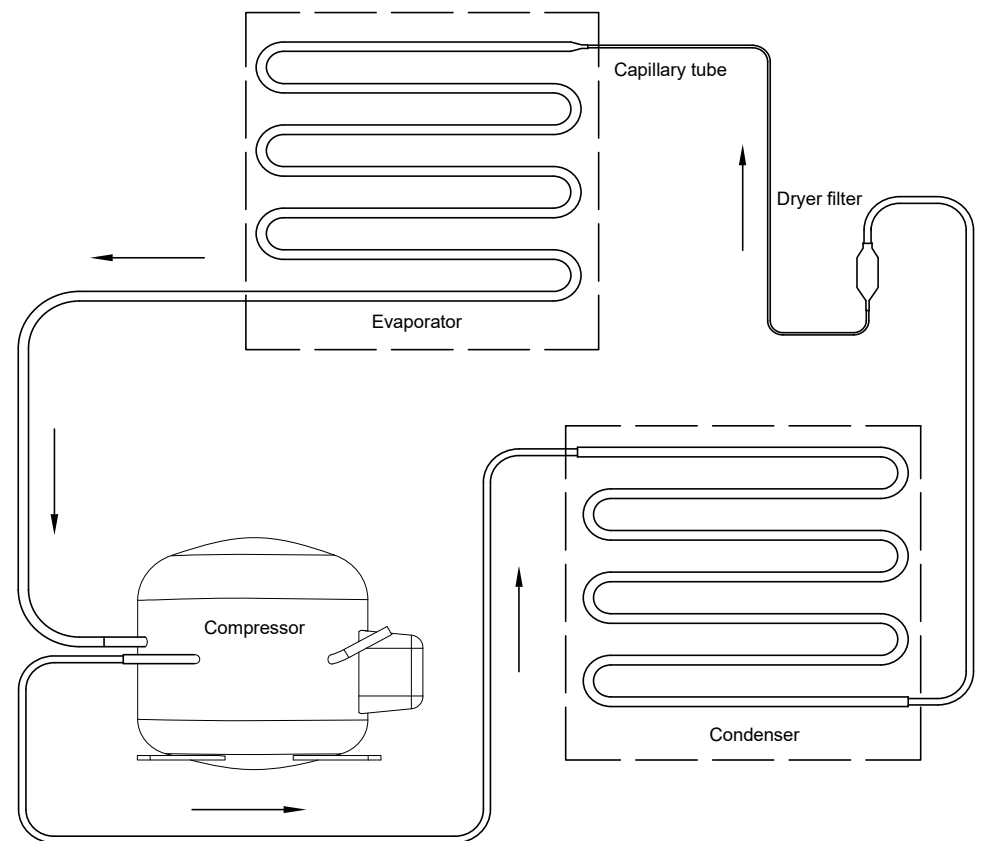

DW-40W380

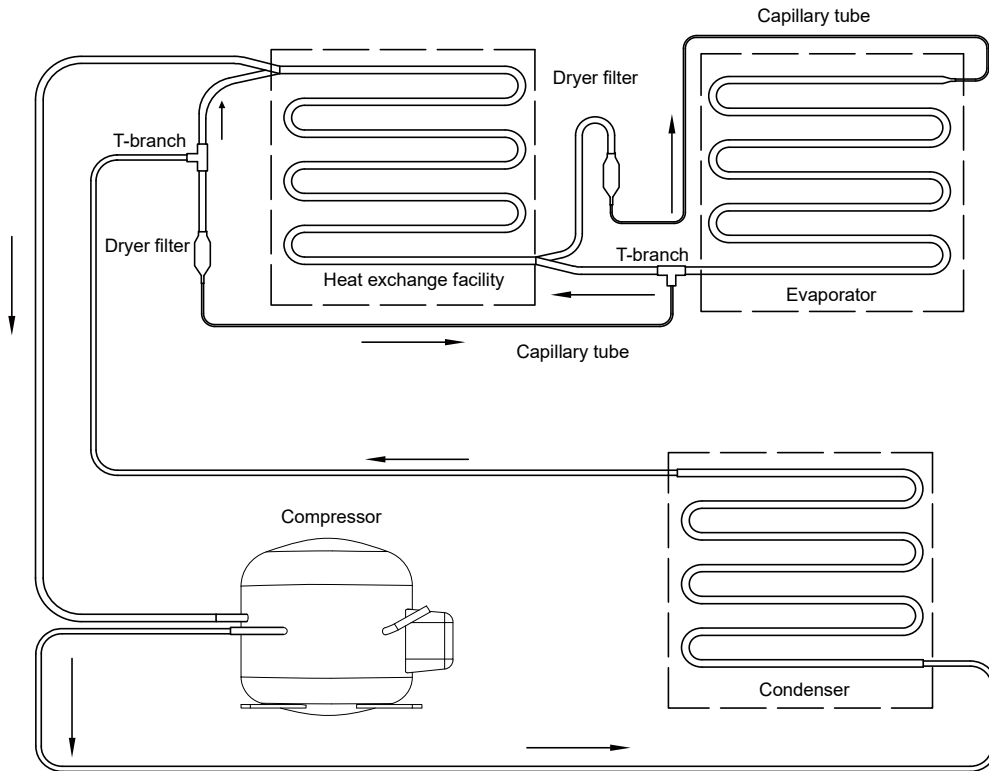

Name of parts _____

DW-25L92/262/300 and DW-40L92/262

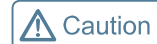

Caution There are 3 drawers in Type DW-25L92 and DW-40L92.

DW-40L278/278J/278(a) and DW-30L278

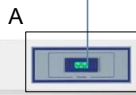
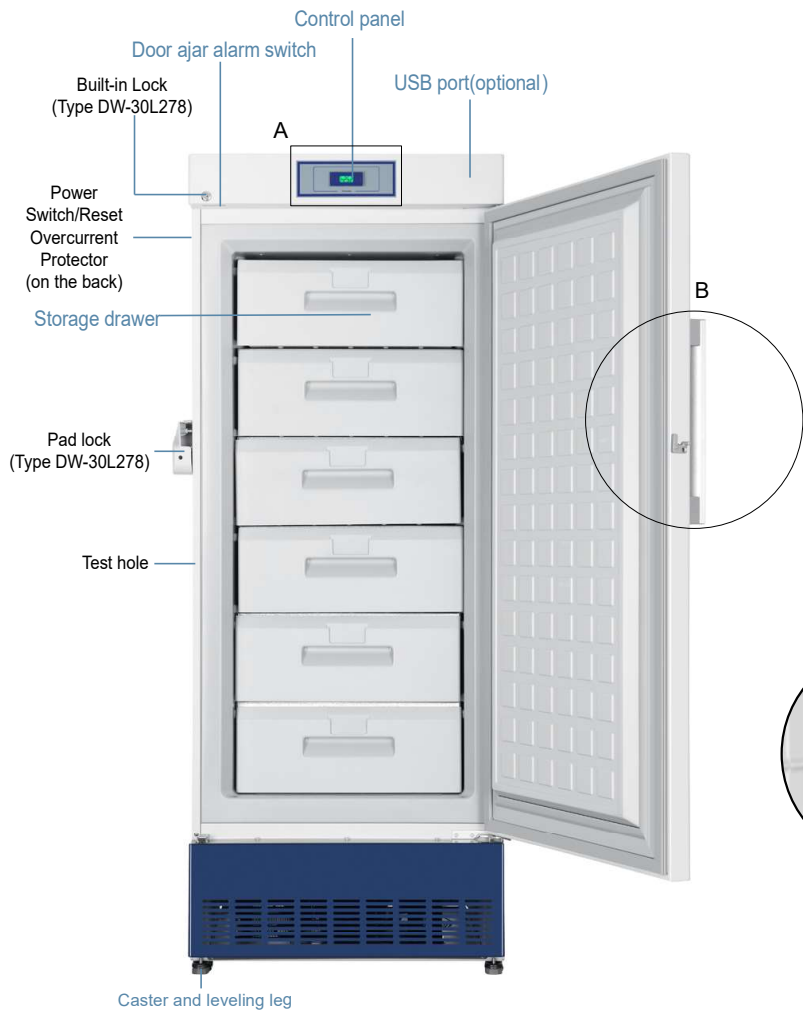

Type DW-40L
A

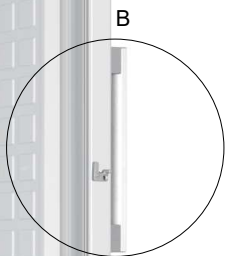

Type DW-40L
B



Caution

- The switches of power/Reset overcurrent protector and battery are at the back of product;
- No door ajar alarm switch, battery switch, and USB interface is equipped within Type DW-30L278;
- The control panel of DW-40L series is different from the DW-30L278, please refer to the A view;
- The handle of DW-40L series is different from the DW-30L278, please refer to the B view.

DW-30/40L420F

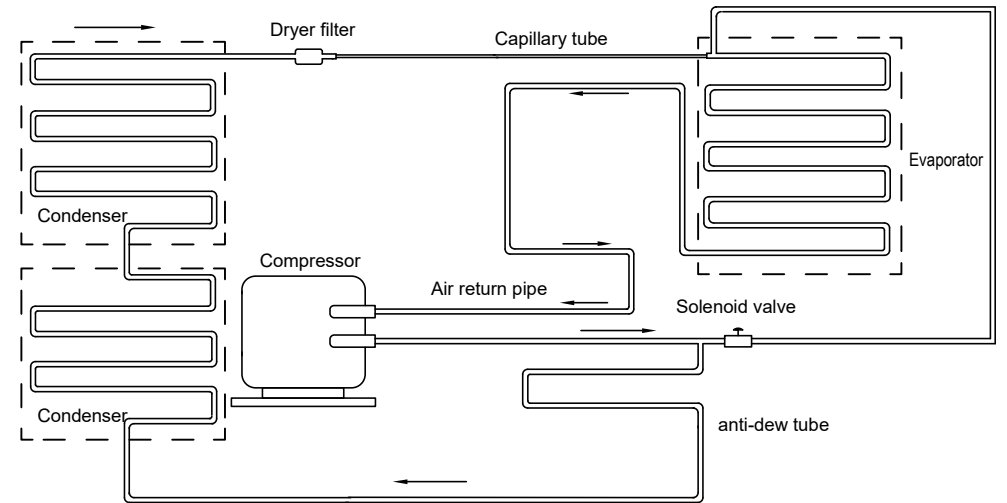

others are for vertical type

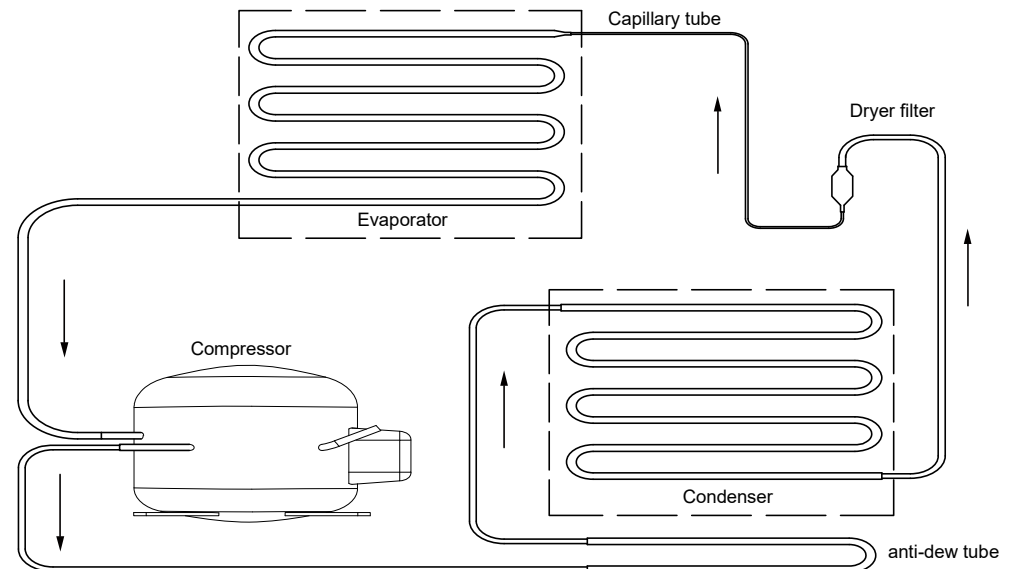

Refrigeration Schematic & Circuit Diagram

Refrigeration schematic

DW-40L348/348J/508/508J/508(a)

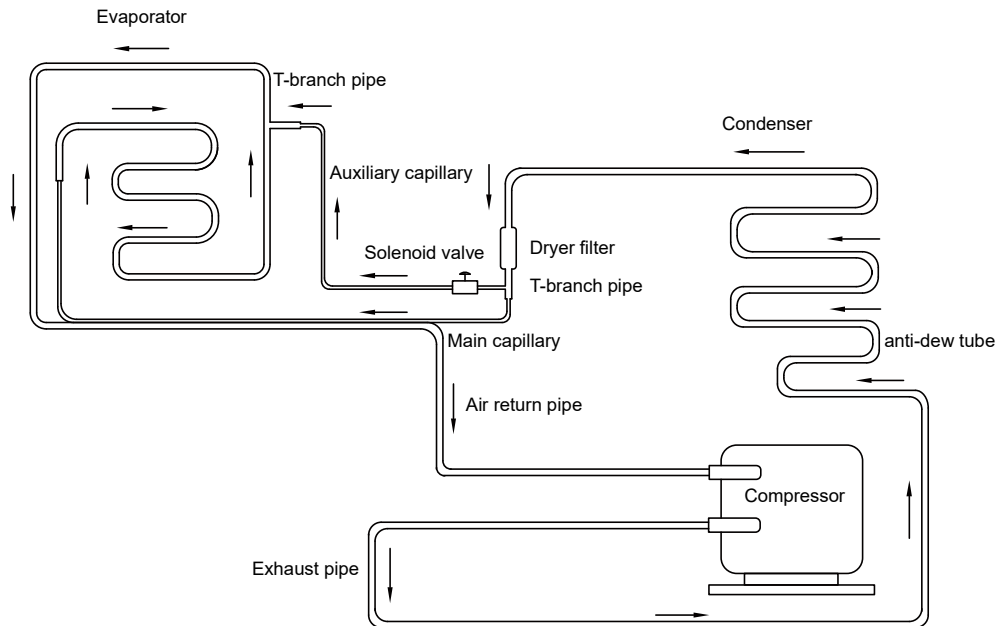

DW-40L348/348J/508/508J/508(a) and DW-30L508

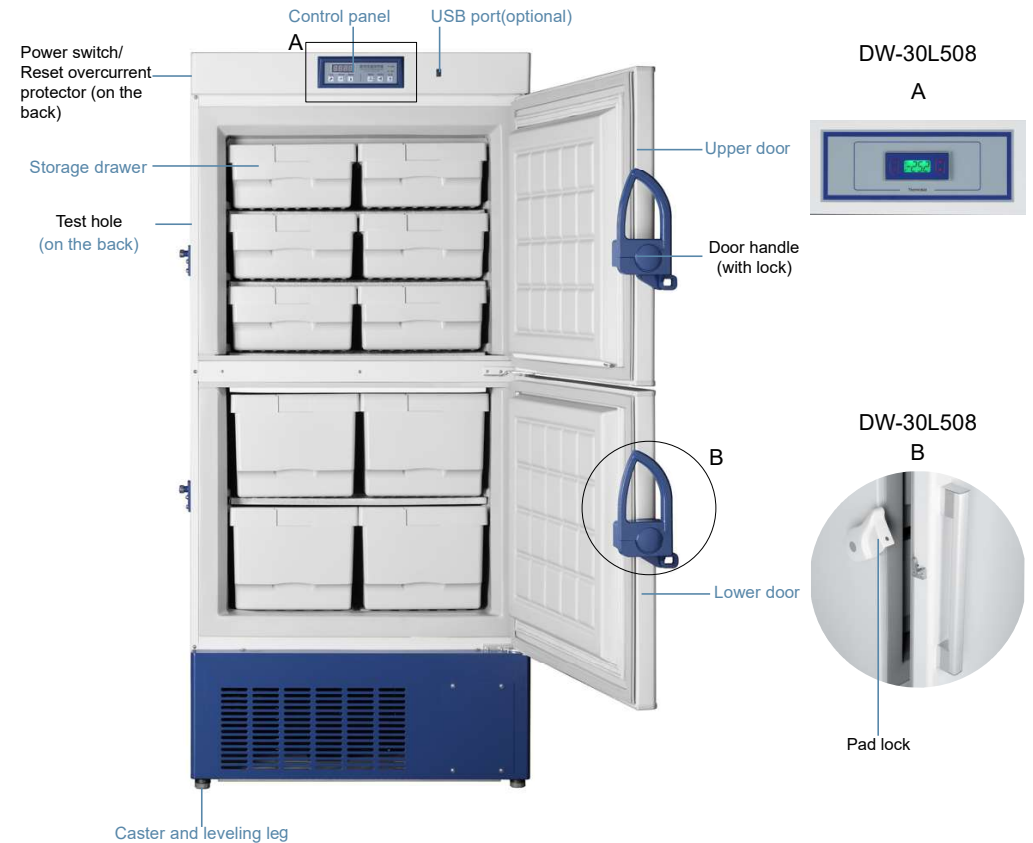

Caution

- The switches of power/Reset overcurrent protector and battery are at the back of product;
- No battery switch and USB interface is equipped with Type DW-30L508;
- There are 12 drawers in Type DW-40L348/348J, 6 of which are located in the upper cabinet and 6 in the lower; while there are 10 drawers in Type DW-40L508/508J/508(a) and DW-30L508, including 6 in the upper and 4 in the lower;
- The control panel of DW-30L508 is different from the DW-40L series, please refer to the A view;
- The handle of DW-30L508 is different from the DW-40L series, please refer to the B view.

DW-30/40L420F



Caution

Any of the following event will be normal, please do not worry about any of it:

- For initial use or start-up, the working time of refrigerating system will be longer and the noise will be more serious, and under the normal condition, you may find out sound like liquid flow, which is caused by the circular flow of refrigerating fluid within the tube;
- There might be a difference between the temperature displayed on the freezer and that at the center of freezer, that's because the sensor is not located at the center. However, the displayed temperature will gradually be closed to that at the center after stable operation of the freezer;
- For radiating tubes are equipped in the outer shell of freezer, the surface temperature of shell will be very high when the freezer is being operated.



If you have any questions about the operation of the unit, please refer to the following first. If an issue persists, contact your after sales office. Do not maintain and dismantle the freezer by yourself!

Fault	Troubleshooting
The freezer does not work	Whether the power connection is normal or not
	Whether the supply voltage is too low or not
	Check whether all the temperature settings are normally.
Poor cooling	Whether the ambient temperature is too high?
	Whether the external door is closed well or not (the frost between the bin and the door seal might stop the door being closed tightly)
	Whether the lock latch is fastened tightly or not
	Whether the temperature setting is correct or not
	Whether the freezer is kept away from direct sun shine or not
	Whether the freezer is closed to any heat source or not
	Whether the rubber hole cover and insulating material for through hole used for test are in place or not.
High noise	Whether too many articles with high temperature are put into the freezer at one time or not
	Whether the freezer is placed on the solid floor or not
	Whether the outer shell of freezer contact with anything or not
	Whether the freezer is leveled by horizontal stand bar or not
High noise	Whether the freezer is under low-temperature operation status (for it will make some noise if the temperature within it becomes higher due to overload, which will be reduced gradually when the temperature becomes lower)
	Please check that whether the noise is made by the compressor (the noise from compressor of low-temperature equipment will be larger than that of home appliance)
	Noise caused by beat (which might be caused by quick cooling shrinkage of parts within equipment, so the temperature should be reduced gradually other than sharply reduction within a short time)

DW-40W100/255/380



Control panel

DW-25L92/262/300 and DW-40L92/262



DW-40L278/278J/278(a)/348/348J/508/508J/508(a)

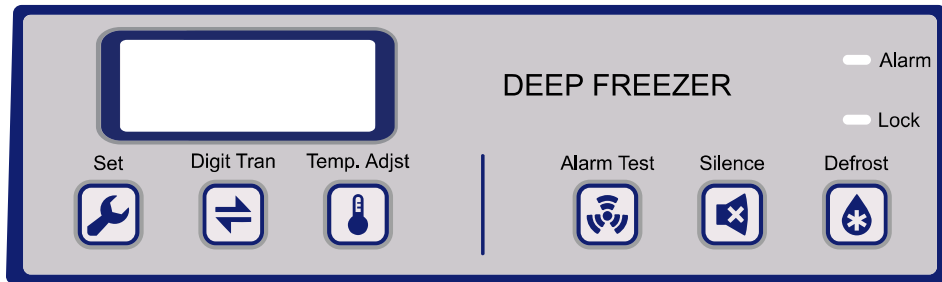

DW-30/40L420F

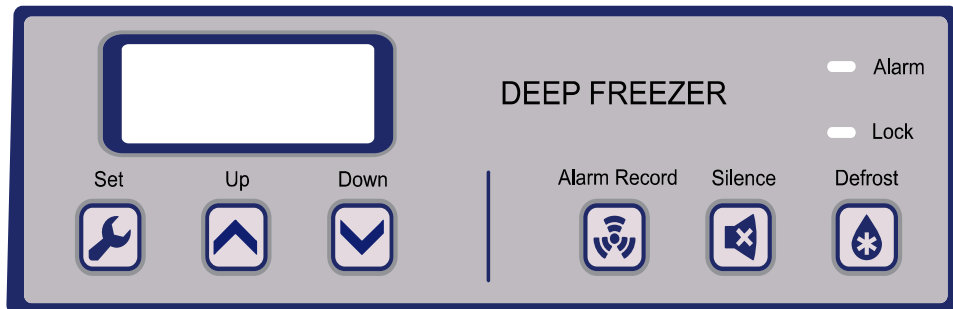

⚠ Caution

Electronic temperature controller is adopted in horizontal type and Type DW-30L278/508, which would not marked here.

The rechargeable battery equipped in the freezer could be recyclable. Therefore, when its service life expires, please contact local organization for battery recycling to check or dump it in a correct way.

Battery location

Rechargeable battery within the freezer is used for outage alarm, which is located in the electric cabinet.

⚠ There are electric appliance components within the electric cabinet. In order to prevent electric shock, the cover should be opened only by professional engineer or maintenance personnel.

Removal of the battery

1. Turn off the battery switch and then pull the plug out of the socket;
2. Screw out all screws on the cover of electric cabinet on top of the bin by screwdriver;
3. Pull out the wiring plug of battery;
4. Unfix the fixers of battery and take out the battery;
5. Recycle or correctly dispose of the battery based on relevant rules.

⚠ For replacement rechargeable battery, it should guarantee that the red wire should be connected with the anode of battery while the black wire with the cathode without any error. Otherwise, the charging circuit of computer board will be easily burnt, and the computer board will not be able to recharge for the battery.

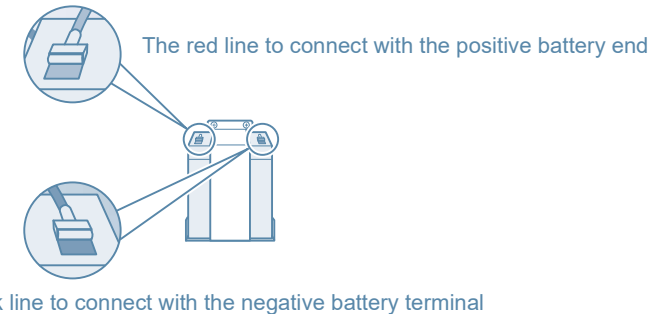

⚠ Caution

Outage alarm rechargeable battery is only respectively equipped in Type DW-40L278/278J/278(a)/348/348J/508/508J/508(a)/420F, DW-30L420F.

Battery Maintenance (DW-40L278/278J/278(a)/348/348J/508/508J/508(a)/420F and DW-30L420F)

- When the freezer is under electrified operation, please ensure that the battery switch keeps on, and the battery will be recharged. After the battery has been continuously recharged for a week, please test the quantity, for it should be full under normal condition. If the quantity is not full, please replace the rechargeable battery.
- The outage alarm battery is consumable, and the service life is 2 or 3 years generally. If any battery has been used for more than 3 years, the outage alarm function will become invalid. The battery should be replaced as soon as possible. For any replacement, please contact the after-sale staff of Haier.

Discarding Disposal of Freezer



Warning

- If the freezer is left unused for a long time in an unattended area, make sure that children will not approach the freezer and the freezer door will not be closed completely.
- The scrap disposal should be carried out by corresponding staff, and the door should be demolished in order to prevent any accident such as asphyxia.

Purchasing of Recording Paper and Standby Battery of Recorder

Temperature recorder is an optional device. The chart papers are custom-made. Additional chart papers can be purchased through Haier.

The 9 V DC battery for the recorder can be acquired anywhere so long it matches the requirement. Customers can also buy high quality replacement battery from Haier.

DW-25L92/262/300 and DW-40L92/262

- Temperature adjustment

After pressing "▲" and "▼" for 3 seconds, the setting temperature would begin to flash, and then press the "▼" once, the temperature would be reduced by 1°C until -40°C /-25°C , and for one more press, it will be back to -10°C ; and then press the "▲" once, 1°C would be added until -10°C , and for one more press, it will back to -40°C /-25°C . it would exit from the setting status and then display the normal temperature if no operation is performed for 5 seconds.

- Temperature setting of hi-low temperature alarm

The default of hi-low temperature alarm is $\pm 5^{\circ}\text{C}$ of setting temperature, and the steps should be followed when setting it:

After pressing "Alarm" + "▲" for 3 seconds, AH (high temperature) would begin to flash, and then press the "▼" once, the temperature would be reduced by 1°C until 1, and for one more press, it will be back to 10; and then press the "▲" once, 1°C would be added until 10, and for one more press, it will back to 1; it would exit from the setting status and save the setting, and then display the normal temperature if no operation is performed for 5 seconds.

After pressing "Alarm" + "▼" for 3 seconds, AL (low temperature) would begin to flash, and then press the "▼" once, the temperature would be reduced by 1°C until 1, and for one more press, it will be back to 10; and then press the "▲" once, 1°C would be added until 10, and for one more press, it will back to 1; it would exit from the setting status and save the setting, and then display the normal temperature if no operation is performed for 5 seconds.

DW-30L278/508

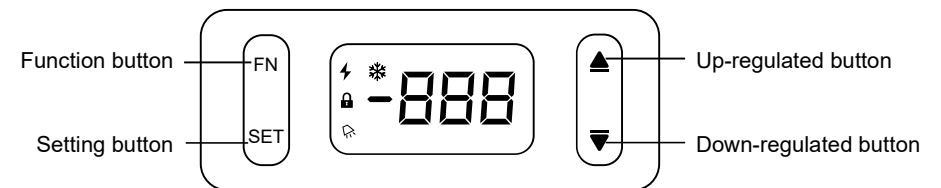

⚡ : Power-on indication--Indicates that power is On

🔒 : Locking indication--Indicates that the screen have been locked

❄️ : Refrigerating indication--indicates that the refrigerating system is in process

🔔 : Alarm indication-- indicates that there is an alarm (with beep generally)



Caution

For a beep alarm, press any key could cancel it.

• Locking and unlocking

For avoiding any mis-operation, the temperature controller could be locked, which would become valid when there is no operation for a long time, and the "🔒" would be illuminated on the screen. For unlock, please press "FN" and "SET" for 1 second until the "🔒" on the screen disappears, and then it is unlocked; for lock, please still press "FN" and "SET" for 1 second, and then the temperature controller will be locked, and the "🔒" on the screen will be illuminated.



The temperature controller will be locked automatically if there is no pressing within 3 minutes. Then it should be unlocked when you need to operate it again.

• Change the setting temperature

In general, the temperature will not be set again, if do, please refer to the steps as follows:

1. Please unlock the controller if the controller is locked;
2. Press "SET" once and then current setting temperature would be shown;
3. Increase or decrease the setting value by "▲" or "▼";
4. Press "SET" once again after you change the temperature to your expected value, and the controller will save the current setting and then exit to normal interface.

• Default setting temperature

The default setting temperature of this product is -25°C .

• Query historical data

The product is equipped with simple function of recording historical data, which can save the maximum value of temperature Ho1 and the minimum value Lo1 recorded within 24 hours of normal operation. For any inquiry, it should be operated by the following steps:

1. Press "SET" for more than 3 seconds, then the digital tube will display the parameter code of "PS" (password);
2. Use "▲" and "▼" to roll the parameter Ho1 or Lo1;
3. Press "SET" to confirm the parameter and then display the value of parameter;
4. Press "SET" to return to the displayed parameter;
5. Use "▲" and "▼" again to roll for inquiring another parameter;
6. Press "SET" to confirm the parameter and then display the value of parameter;
7. Press "SET" for more than 3 seconds to return to normal.



- The extreme value available for inquiry should be data within 24 hours. If the operating time could not last for 24 hours after start, the extreme value for current time will be displayed after start.
- When inquiry, if press Fn for 1 second, this record will be deleted (the value will be changed to measured value by current sensor).

|| Cleaning component



Caution

- Turn off the power before any maintenance work is performed.
- Do not inhale any airborne particles around the unit while performing maintenance.

Freezer cleaning

- Clean the freezer once a month. Regular cleaning can keep the appearance of the freezer a brand new look.
- Wipe out the dust on shell, chamber and all the accessories of the freezer with a dry cloth. If the freezer is too dirty, remove the dirt with a clean cloth dipped with neutral detergent and wipe out the residues with a wet cloth. Then wipe with a dry cloth.
- Do not pour water on the shell or in the chamber of the freezer. Otherwise, it may damage the insulation of the electrical equipment and may lead to the occurrence of fault.
- Mechanical compressors are hermetically sealed. They do not need lubrication.
- Conduct defrosting or deicing for the inner wall once every month.

Defrosting for inner wall

After under operation for a certain time, the frost will be formed on the inner wall of freezer, which might affect the normal refrigerating effect if it is too thick, and might consume more energy. Therefore, after a certain time of operation, when the thickness of frost reaches to 5mm around, you should use the attached defrosting shovel to clean it according to the following steps

- Take out the articles kept in the bin and move to appropriate site;
- Switch off the power switch;
- Open the outer and inner doors for a while in order to defrost naturally;
- After frost melts well, discard the water from the drawers or drain it from the drainage hole
- Dry the bottom of bin with a dry cloth;
- Restart the equipment after the bin is cleaned well;
- Put all articles back in the bin that has already been cooled down.



Caution

- Do not use knife or screwdriver or similar tools with sharp edges to defrost.
- For freezer with defrosting function (such as DW-40L278/278J/278(a)/348/348J/508/508J/508(a)/420F and DW-30L420F), you could press "Defrost" on the computer board for 5s after keyboard is unlocked, and the compressor will stop for operation. However, this key could not recover the status automatically(DW-30/40L420F could be recovered automatically without pressing), so, you should press this key for 5s again after defrosting is completed, and the compressor will be recovered for normal operation.
- Defrosting should be carried out once per month, up to once per three months.

Horizontal cabinet series

- When the temperature captured by sensor is higher than +5°C (or higher than the setting value of high-temperature alarm), "AH" and temperature will be alternately shown; when the temperature captured by sensor is lower than -5°C (or lower than the setting value of low-temperature alarm), "AL" and temperature will be alternately shown.
- For any short circuit, open circuit, or fault, or incorrect connection happens on the temperature sensing probe, "Err" will be shown, and when the sensor's temperature is higher than 85°C, "EHi" will be shown, and when lower than -50°C, "ELo" will be shown. At the same time, the beeper for temperature controller will be initiated, and corresponding alarm parameter (such as Err, Ehi, Elo) will be shown on the screen correspondingly, as well as the alarm mark (without display of temperature).



Caution

- If the temperature sensing probe is judged for error, power should be cut off, and the connection of sensing probe should be checked firstly.
- If any internal code is shown when the user is adjusting the temperature controller, please wait for 1 minute until the temperature is shown again, in order to prevent from any fault due to any change of control parameter.

Automatic recovery of alarm

- Under alarm, the beeper alarm could be ceased by pressing the cancellation key on board (for Type DW-30L278/508, press any key, and the flashing alarm and remote alarm will not be ceased).
- If the alarm condition is still available, the beeper alarm will be recovered automatically 30 minutes after cease.



Caution

DW-25L92/262/300, DW-40L92/262 and DW-30L278/508 is not equipped with such function.

Remote alarm terminal

Remote alarm terminal is respectively equipped in Type DW-40L278/278J/278(a)/348/348J/508/508J/508(a)/420F and DW-30L420F:

- Remote alarm terminal is equipped on top of freezer, and the alarm signal of electric cabinet should be output via the terminal. The carrying capacity of such terminal is 30V, 2A, DC.
- Contact output:

Remote alarm terminal could be classified into three types, including normally open, normally closed, and public. Users may select NO or NC according to their own requirements.



Caution

The remote alarm function should be initiated after the user installs the alarm device, which should be used cooperating with remote alarm interface.



- Temperature setting of hi-low temperature alarm

When unlocking,

1. Press "SET" for more than 3s, then the screen will display the parameter code of "PS" (password);
2. Press "SET" button to enter password setting;
3. Use "▲" and "▼" to roll the figure to "-15";
4. Press "SET" to confirm the password;
5. Use "▲" and "▼" to roll the parameter name (the parameter of high temperature alarm is AH, and that of low temperature alarm is AL);
6. Press SET to display corresponding parameter value;
7. Use "▲" or "▼" to add or reduce the value of parameter;
8. Press "SET" button to temporarily save the modified parameter value and return to the display parameter;
9. When modifying other parameters, repeat steps 5~8;
10. Press "SET" for more than 3s to save the revised parameter and then exit the parameter setting procedure.

Note: It will exit the setting procedure and then lock the controller if there is not any pressing within 3 minutes, and it will perform based on the parameter set at last.

DW-40L278/278J/278(a)/348/348J/508/508J/508(a)

- Unlocking

When the indicating light of "Lock" is turned on, all keys except "Digit Tran" will be locked, and it should be unlocked before setting any parameter. For unlock, the following steps should be followed:

1. Press "Digit Tran" for more than 5 seconds, then "F0" will be shown, while the Digit "0" will flash;
2. Press "Temp. Adjst" once and "F1" will be shown on the display area;
3. Press "SET" once, the indicating light of "Locked" will be off and the keyboard will be unlocked.

- User parameter setting

User could change the setting temperature of freezing chamber, alarm value, start delay, and other parameters via control panel.

1. Parameter inquiry and setting
 - a. Under the unlock status, press "SET", "L0" will be shown on the screen, and Digit "0" will flash;
 - b. Press "Digit Tran" could change "L0" to L1, L2, L3, L4, or L5;
 - c. After the designated parameter is set, press "SET" once again, the setting value will be shown on the screen, and the value of digit unit will flash. the list corresponding to parameter codes is as follow:

Parameters code	Parameter meaning	Parameters code	Parameter meaning
L0	Control temperature setting	L3	Inquiry of current voltage
L1	High-temperature alarm value setting	L4	Current ambient temperature query
L2	Low-temperature alarm value setting	L5	Delay of door ajar alarm

- d. Press "Digit Tran" to change the flashing digit, and then press "Temp. Adjst" to change the value of current digit;
- e. Adjust to the required temperature value and then press "SET", the parameter will be changed and saved.



- The default setting temperature is -36°C ;
- Door ajar alarm delay will be only applicable to DW-40L278/278-ARQ/278J;
- The voltage and ambient temperature value could only be inquired other than being set;
- The range for setting hi-low temperature alarm is as follow:
Maximum setting temperature + 5°C ≥ high temperature alarm value ≥ set temperature + 5°C .
Minimum setting temperature - 5°C ≥ low temperature alarm value ≥ set temperature - 5°C .
- For indication, the symbol "┆" before the number refers to "+".

2. Setting start delay

- Under the unlock status, press "SET" and "Temp. Adjst" for 5 seconds at the same time, the current start delay time will be shown on the screen;
- Press "Temp. Adjst" could change the start delay time;
- Adjust to the required value and then press "SET", the parameter will be changed and saved.

3. Defrosting

Under the unlock status, press "Defrost" for more than 5 seconds, the refrigerating system of freezing chamber will cease for operation, and "dF" will be shown on the screen. This status could not be recovered automatically, but could only be exited after pressing "Defrost" for more than 5 seconds again. While successful exit, "dF" will not be shown on the screen again.



For any adjustment of parameter, the system will save current setting and then exit the setting mode if there is no operation within 10 seconds;

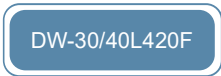

• Temperature adjustment

Press "Set" and then "Ts" will be shown on the screen; press "Set" again, current setting temperature will be shown, the default is "-25.0", which could be increased or decreased via "▲" or "▼". After entering the setting value, press "Set" for 5 seconds to save it and display current temperature. During the process above mentioned, the setting of parameter will not be saved if there is no operation on any interface for 10 seconds, and then it will return to display the current temperature.

• DIS parameter inquiry

Press "▲" and "▼" at the same time, "PS" will be shown on the control panel; then press "Set", "00" will flash; press "▲" or "▼" to enter the correct password (default is 06); press "Set" to enter the interface for adjusting system parameter: firstly, "DIS" parameter will be shown, and the first "DIS1" will be shown after pressing "Set"; and the value of "DIS1" will be shown after pressing "Set" once again, and then it will return to show "DIS1" after pressing "SET" once again. By "▲" and "▼", you may inquire the value of "DIS2", "DIS3", "DIS4", and then press "Set" to return after review. Press "Set" again to return to show "DIS". You may exit the parameter inquiry interface if there is no operation on any interface of inquiry above mentioned for 10 seconds, and then current inner temperature will be shown.



After connecting with the power, the freezer start working, and the inner temperature will be shown on screen.

• Historical alarm query

When the inner temperature is shown normally, press the "Alarm Record" for 5s, and "HIS" will be shown on the panel (Inquiry of alarm history), and then press "Alarm Record" once again and enter the inquiry list of over-temperature alarm history, including four parameters: AL1, AL2, AUL, and HAt.

Parameters code	Instruction
AL1	The highest temperature in the last alarm process
AL2	The lowest temperature in the last alarm process
AUL	Average temperature in the last alarm process
HAt	Lasting time in last alarm (unit: minute)

Select parameter by "▲" and "▼", and press "Alarm Record" to check the parameter value, then return by pressing "Alarm Record" again after completing checking, and then could select another parameter code for inquiry. After completion of parameter value inquiry, press "Alarm Record" twice to return to "HIS". You may exit the parameter inquiry interface if there is no operation on any interface of inquiry above mentioned for 10s, and then current inner temperature will be shown.

For inquiry of HIS parameter during over-temperature alarm, the parameter value for such alarm will be displayed; otherwise, the parameter value for the last alarm will be displayed. The alarm history parameter should be saved in memory within 30min after completion of each over-temp. alarm.

• Cause of alarm

Alarms	Status	Fault code	Indication	Beeper
High temperature alarm	When the inner temperature is higher than the setting temperature of alarm	E9	Alarm indicator flashes	For the first starting up, 3h after default setting, start buzzing alarm function. When in normal operation, make the buzzing alarm after delay for 15 min.
Low temperature alarm	When the inner temperature is lower than the setting temperature of alarm	E10	Alarm indicator flashes	
Power failure alarm	Power failure of equipment	/	Alarm indicator flashes, the black screen and inner temperature are on the display screen alternatively	Beep alarm will be sent after 1min delay.
Excessive ambient temperature	The ambient temperature is above 38 °C	E14	Alarm indicator flashes	The buzzer does not alarm
Sensor exception	Fault occurs on the main sensor in refrigerator	E2	Alarm indicator flashes and E2 code is displayed	Buzzer alarm
	Fault occurs on the combinetemperature sensor	E1	Alarm indicator flashes and E0 code is displayed	Buzzer alarm
	Fault occurs on the display sensor	E0	Alarm indicator flashes and E1 code is displayed	Buzzer alarm
Low battery	The battery is low or the battery switch is not turned on	E5	Alarm indicator flashes	The buzzer does not alarm
Door ajar alarm	The door is opened or not closed tightly	E6	Alarm indicator flashes	Buzzer alarm

DW-40L278/278J/278(a)/348/348J/508/508J/508(a)

After connecting with the power, the freezer start working, and the inner temperature will be shown on screen panel.

• Working status of the display panel:

"Lock" pilot lamp: it is ON referring to that all settings are locked to avoid maloperation.

"Alarm" pilot lamp: it is ON or flashing referring to the occurrence of fault.

• Function key

Stop beeping: under lock or unlock, the beep sound could be ceased by pressing "Silence" (recover in 30 minutes), but flashing light alarm could not be ceased.

Alarm test: it is used to test that whether the alarm system is under normal status and whether the battery is low in power or not. Under unlock, press such key, all indicating lights will be on, and beeper will sound, and "8" will be shown on all digital tubes. Under lock, press such key when any alarm sounds, corresponding fault alarm code will be shown, and the reason could be inquired by the list as follow:

Alarms	Status	Fault code	Indication	Beeper
High temperature alarm	When the temperature in the bin is higher than the set value of high temperature alarm	E9	Alarm indicator flashes	Beep alarm will be initiated in 5h after initial start, which will send alarm for 15min delay under normal work.
Low temperature alarm	When the temperature in the bin is lower than the set value of low temperature alarm	E10	Alarm indicator flashes	
Power failure alarm	Power failure of equipment	/	Alarm indicator flashes, the black screen and inner temperature are on the display screen alternatively	Beep alarm will be sent after 30s delay
Excessive ambient temperature	The ambient temperature is above 38 °C	E14	Alarm indicator is always on	-----
Abnormal sensor	Fault of the main sensor in the bin	E6	Alarm indicator flashes and E6 code is displayed	Buzzer alarm
	Ambient temperature sensor fault	E0	Alarm indicator flashes	-----
Low battery	The battery is low or the battery switch is not turned on	E5	Alarm indicator is always on	-----
Door ajar alarm	Door is open or is not closed tightly.	E7	Alarm indicator flashes	Delay (10min by default) and then beeper will sound

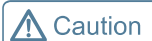

For more than one alarm is initiated, each code of alarm fault will be shown for 3s respectively.

DIS display parameter:

Parameters code	Instruction
DIS1	Show the current temperature value of inner sensor (before adjustment)
DIS2	Display the current temperature value of the display sensor
DIS3	Show the current temperature value of ambient temperature sensor

• Restore factory setting

Pressing "Set" + "▲" + "▼" 10 seconds at the same time, to restore factory setting.

Horizontal cabinet series

• Electronic temperature controller

Electronic temperature controller is equipped on the control panel of freezer, and the actual temperature within the bin will be shown on the digital screen after being electrified. Schematic diagram of electronic temperature controller.

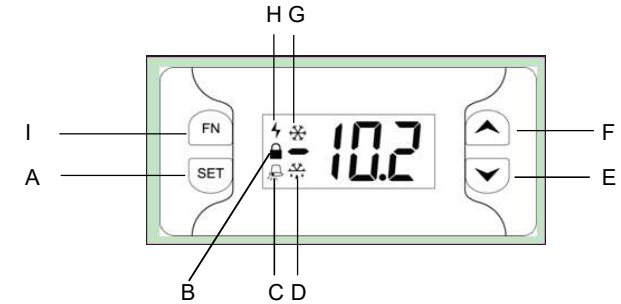

A	Setting button	F	Add button
B	Locking indication	G	Refrigeration status
C	Alarm indication	H	Power indication
D	Defrosting indication	I	Function button
E	Decrease button		

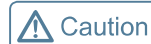

• Under normal use, the setting temperature will not be adjusted generally. Any adjustment might cause Hi (AH) or low (AL) temperature alarm, and at that time, please adjust the value of hi-low temperature alarm (AH, AL) at the same time.
 • Generally, the value of hi-low temperature alarm should be set within the range of ±5°C .

• Temperature setting

Current temperature value will be shown on the screen after the freezer is electrified. If the setting temperature should be set again, for example: if the previous setting temperature is -20°C , and now it should be adjusted to -25°C , please follow the steps by numbers:

Alarm

No.	Button operation	Display
1		Display the temperature in bin
2	Press SET and FN for 3s at the same time to unlock	🔒 disappear on the display screen
3	Press SET for more than 3s	Show the setting value -20 and flash
4	Adjust by pressing decrease key ▼ (▲ is for increase)	Change setting value to -25
5	Press SET for more than 3s and save the setting value	Stop flashing and show the temperature

- Adjust the temperature alarm limit

In order to keep the articles within the freezer safe, the electronic temperature controller should be equipped with alarm. When the temperature is higher than the upper threshold of alarm or lower than the bottom threshold, beep will be initiated, and the alarm figures will be shown alternately with current temperature on the screen (Note: AH for high temperature alarm and AL for low temperature alarm), and beep will be invalid after pressing any key (but the alarm figure will be still shown on the screen). When the temperature falls between the upper and bottom thresholds again, the alarm will stop.

While being electrified under normal condition, the current temperature value will be shown on the screen, and the alarm value will be set between AH and AL, namely: the alarm upper threshold=AH setting value; while the bottom threshold=AL setting value; for example, for changing the alarm upper threshold from -15°C to -10°C, while the bottom threshold from -25°C to -30°C, please follow the following steps:

No.	Button operation	Display
1		Display the inner temperature
2	After unlock, press SET +▲ at the same time for more than 3s	Display AH
3	Press SET	-15
4	Via pressing the increase button ▲	-10
5	Press SET to confirm parameter	AH
6	Press the increase button ▲	Until Display AL
7	Press SET	-25
8	by pressing decrease key ▼	-30
9	Press SET to confirm parameter	AL
10	Press SET for more than 3s to save setting value	Display the inner temperature

DW-25L92/262/300 and DW-40L92/262

- If the temperature sensed by the sensor exceeds $\pm 5^{\circ}\text{C}$ or setting alarm temperature, the red light will flash for alarm together with beep. When short circuit, open circuit, or any fault happens on the temperature probe, "F1" will be shown on the temperature display area;
- When the freezer is turned to protected mode, the compressor will work in a fixed cycle of "starting for 20min and ceasing for 5min", and the red light will flash while the alarm sound will become invalid. Suggestion: If the temperature sensing probe is judged for error, power should be cut off, and the connection of sensing probe should be checked firstly.
- When the temperature sensed by the sensor is higher than 34°C , "HH" will be shown; while the temperature is lower than -45°C , "LL" will be shown.

DW-30L278/508

Alarms	Symptom	Alarm indicator	the buzzer alarms
High temperature alarm	If the inner temperature sensed by the sensor is higher than -15°C or the setting high-temperature alarm value,	The alarm light will flash and "Hi" and inner temperature will be alternately shown on the temperature display area.	Alarm will be initiated by impulsive sound immediately
Low temperature alarm	If the inner temperature sensed by the sensor is lower than -35°C or the setting low-temperature alarm value,	The alarm light will flash and "Lo" and inner temperature will be alternately shown on the temperature display area.	Alarm will be initiated by impulsive sound immediately
Higher limit alarm for temperature	If the temperature sensed by the sensor is higher than 85°C	The alarm light will flash and "EHi" will be shown on the temperature display area.	Impulsive sound alarm
Lower limit alarm for temperature	If the temperature sensed by the sensor is lower than -50°C	The alarm light will flash and "ELo" will be shown on the temperature display area.	Impulsive sound alarm
Power failure alarm	Power failure of the freezer	The inner temperature will be shown on the temperature display area by turns for 24h (when the battery is fully charged)	Buzzer for 2 min
Sensor exception	Short circuit or open circuit of temperature sensor	The alarm light will flash and "Err" will be shown on the temperature display area.	Impulsive sound alarm

Caution

- For any outage, the fully-charged controller could keep working for sending alarm for 24h. For initial start of freezer or after a long time of outage, you should firstly charge the battery fully, and keep the freezer under operation for continuous 12h.
- When the sensor fails, the system will enter into a self-protecting operation status, the refrigerating system will automatically run for 8min by default, and then cease for 9min, which will become a cycle operation until the fault is eliminated.
- For the function above mentioned, some differences might appear on different models, so please subject to the machine you have bought.

setting. If during the setting process, you press "Set", "Digit Tran", and "Temp. Adjst" again for over 5s, it will save the setting and exit at once. Normal temperature will be shown on the screen.

- Setting the time for recording data by U disk interface (setting the system current time) (DW-30/40L420F):

Press "Down" for 5s, then the left two digits on the screen (2 digits from left to right) would stably show "1P" and the right two digits (2 digits from right to left) will show the Year by flashing (10 by default); press "Up" once, 1 year will be added, while press "Down" once, 1 year will be reduced. It could show in a cycle from 10 to 30; and then press "Set" to save after setting is completed. When the left two digits on the screen (2 digits from left to right) stably show "2P" and the right two digits (2 digits from right to left) show the Month by flashing (01 by default); press "Up" once, 1 month will be added, while press "Down" once, 1 month will be reduced. It could show in a cycle from 01 to 12; and then press "Set" to save after setting is completed. When the left two digits on the screen (2 digits from left to right) stably show "3P" and the right two digits (2 digits from right to left) show the Date by flashing (01 by default); press "Up" once, 1 day will be added, while press "Down" once, 1 day will be reduced. It could show in a cycle from 01 to 31; and then press "Set" to save after setting is completed. When the left two digits on the screen (2 digits from left to right) stably show "4P" and the right two digits (2 digits from right to left) show the Hour by flashing (01 by default); press "Up" once, 1 hour will be added, while press "Down" once, 1 hour will be reduced. It could show in a cycle from 00 to 23; and then press "Set" to save after setting is completed. When the left two digits on the screen (2 digits from left to right) stably show "5P" and the right two digits (2 digits from right to left) show the Minute by flashing (01 by default); press "Up" once, 1 minute will be added, while press "Down" once, 1 minute will be reduced. It could show in a cycle from 00 to 59; and then press "Set" to save after setting is completed. If there is no pressing within 10 seconds during the setting process, it will exit without saving the setting and then show the inner temperature. If "Set" is being pressed for 5 seconds during setting process, it will exit after saving and then show the inner temperature.

- Overcurrent protector operation

1. Installation location: the device is installed on the back of freezer, and it is marked with a special warning sticker.
2. Working principle: when the internal circuit of the product abnormally reaches the protection limit of the overcurrent protector (12A), the device will automatically pop up to disconnect the external circuit and play the role of protecting the entire circuit; When it is reused, you need to manually press this device after the product is powered on.

Test holes

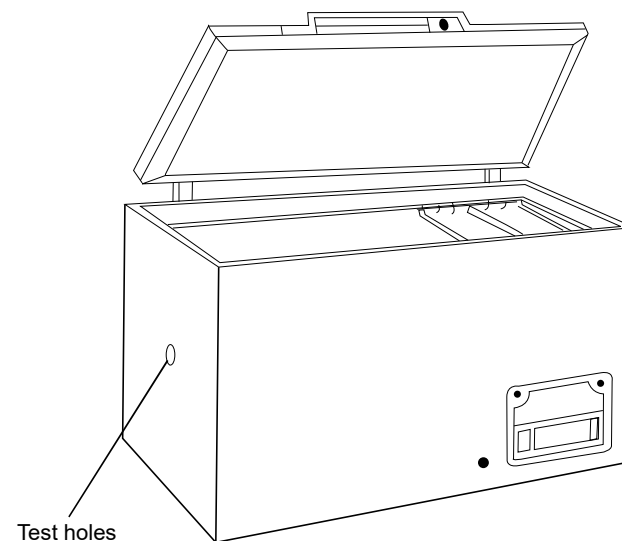

- Purpose

1. Relevant test should be carried out by putting the test line in the freezer to test the articles or environment within it.
2. Balance the pressure in and out of the bin in order to open the door cover easily.

- Use method

1. For any data test, you should only open the end caps of braiding at both terminal of the test hole, and then put in the test line, and stuff the hole with the end caps, which are made of rubber so that the test line will not be test line.
2. If the temperature within the bin is too low, the door cover will be difficult for open, that is because the pressure within the bin is too small due to low temperature. At that time, you could open the end cap at the outer side of test hole in order to reduce the internal pressure, so that the door cover could be opened.

⚠ Caution

- The picture above is only a schematic diagram, and the test hole is located at different site due to different model, so please carry out relevant operation based on the model you have bought.
- After leading out the measuring line, please stuff the test hole with heat insulating materials again, otherwise the temperature within the freezer would stay high, and dew or frost would be condensed surrounding to the outside of through-hole.

Temperature recorder

Inner temperature recorder with 6-inch standard panel could be optionally equipped with Type DW-40L278/278J/278(a)/348/348J/508/508J/508(a)/420F and DW-30L420F to record the change of inner temperature.

• Installation and operation

In order to operate and use recorder correctly, please follow the following steps:

1. Open the recorder door, and the recorder can be seen;
2. Switch on the 9V DC battery on the upper right of recorder, which is a spare power;
3. Check the paper of recorder, which should be replaced based on the operation steps stated in P27 as needed.
4. Take down the plastic cover of recorder pen and then close the door of recorder.



Caution

The recorder will start working until the inner temperature falls in the recording range.

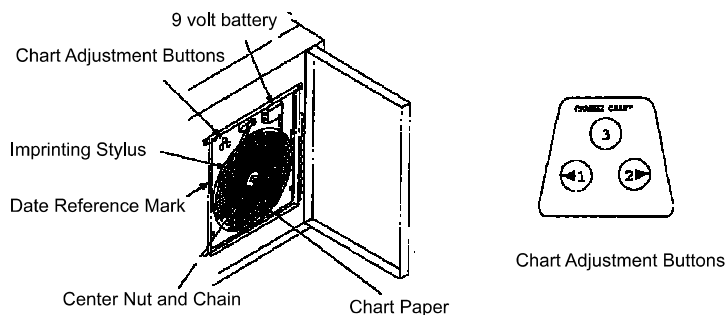

• Power Supply

AC power should be adopted for operation of freezer when the recorder is under normal condition. If AC power supply fails, the LED indicating light on the recorder will flash to indicate that the power supply is abnormal. The recorder will continue to record the inner temperature by spare battery. Each spare battery could sustain for about 30 hours (note: such battery should be replaced timely when the quantity is low, so as to prevent corrosion of battery button due to not-timely replacement). In order to save the battery, please switch off the battery button when the freezer is not in use. In normal process, please install spare battery well in order to take records normally under outage condition. The LED indicating light of recorder would continue to flash until the main power (AC power) is connected and its spare battery is replaced. When the power of spare battery is low, LED indicating light of recorder should be replaced.

• Repair and replacement of spare battery of recorder

When the green LED light of recorder is flashing, there are two ways of checking, including:

1. Remove the spare battery. If LED light is off and the recorder stops, it means that the main power (220V/50Hz) of recorder is in trouble, so that you should check that whether any outage, short circuit, or loose wiring happens. If the main power is repaired, then the recorder could work under normal condition, and please install the spare battery now. If the LED light stop flashing, it means that the spare power is normal. If the LED light keeps flashing, it means that the spare battery is low in power,

USB-Connector

• USB interface functions

USB computer board could save 10 years of test data, which will collect data once every 6 minutes and then save it automatically; after memory is fully occupied, the latest data will automatically replace the earliest one.

1. Format for saving exported data: the format of exported data will adopt *.CSV, each CSV file refers one month of data with a file name of "Year+Month. CSV". One year of exported data will be saved in a folder automatically, which will named with the current year.
2. Treatment of abnormal exported data: any abnormal status will be filled with corresponding characters; for example, "NULL1" means outage fault; while "NULL2" means communication fault of USB board and main control panel.
3. Export data: After the U disk is plugged, it will automatically recognize the U disk and import data into it. Under locked status, you could rapidly press SET for 1 second (press "Up" for Type DW-30/40L420F), and then "USB" will be shown on the display panel in a cycle of "1 second on and 1 second off", which means that data is being imported into U disk. If import is not completed, it will exit and return to show current temperature after flashing for 5s. If "ALL" is shown steadily on the display panel, it means that data has already been completed, and it will exit and return to show current temperature after 5s. Take U disk from USB interface. Format of exported data is as follow:

No.	Time	Setting Temp.	Inner Temp.
00000	20130425 11:40	-40.0	-40.1
00001	20130425 11:46	-40.0	-40.2
00002	20130425 11:52	-40.0	-40.0
...

• Setting the time for recording data by U disk interface (setting the system current time) (DW-40L278/278J/278(a)/348/348J/508/508J/508(a)):

After it is unlocked, press "Set", "Digit Tran", and "Temp. Adjst" for over 5s, then the left two digits on the screen (2 digits from left to right) would stably show "1P" and the right two digits (2 digits from right to left) will show the Year by flashing (10 by default); press "Temp. Adjst" once, 1 year will be added, and it could show in a cycle from 10 to 30; and then press "Set" to save after setting is completed. When the left two digits on the screen (2 digits from left to right) stably show "2P" and the right two digits (2 digits from right to left) show the Month by flashing (01 by default); press "Temp. Adjst" once, 1 month will be added, and it could show in a cycle from 01 to 12; and then press "Set" to save after setting is completed. When the left two digits on the screen (2 digits from left to right) stably show "3P" and the right two digits (2 digits from right to left) show the Date by flashing (01 by default); press "Temp. Adjst" once, 1 day will be added, and it could show in a cycle from 01 to 31; and then press "Set" to save after setting is completed. When the left two digits on the screen (2 digits from left to right) stably show "4P" and the right two digits (2 digits from right to left) show the Hour by flashing (01 by default); press "Temp. Adjst" once, 1 hour will be added, and it could show in a cycle from 00 to 23; and then press SET to save after setting is completed. When the left two digits on the screen (2 digits from left to right) stably show "5P" and the right two digits (2 digits from right to left) show the Date by flashing (01 by default); press "Temp. Adjst" once, 1 minute will be added, and it could show in a cycle from 00 to 59; and then press "Set" to save after setting is completed. If there is no pressing within 10s after the setting process is completed, it will exit and automatically save the

2 After 3 seconds, the stylus will move from -40°C to -20°C and then stay there for 3s, and you could tune the pointer by means above mentioned at this time;

3. After that, the stylus will move from -20°C to 0°C and also stay there for 3s, and you could also tune the pointer as the same way;

4. After 3s, the stylus will move the scale corresponding to the temperature sensed currently and then the calibration is completed.

- Replacing the record paper

After one recording cycle, you must replace a new piece of paper by the following steps:

1. Press 3# once and then the stylus will move to the outside;

2. After the stylus moved to the outside of the paper completely, you could loosen the tightened bolt and then replace a new piece. Please carefully align the scale of initial time on paper with the base line on panel;

3. After tightening the bolt again, you could press 3# once again, and then the recorder will enter into the mode of paper calibration. You may calibrate the paper by reference to the instructions stated in the last page;

4. After the calibration is completed, the temperature recorder will be under normal operation.

- Time setting of recorder and ID (number of recorder) setting

1. Insert the memory card into the recorder, and the indicating light of memory card will flash;

2. Press B. If time and ID have already been set in the memory card, the recorder will update its time and ID, and will delete all records in it such as temperature and time;

3 After completion, the indicating light of memory card will stay on, otherwise it will keep flashing;

- Data reading of recording apparatus

1. Insert the memory card into the recorder, and the indicating light of memory card will flash;

2. Press A. If there is enough space in memory card, data will be sent to it, and then after completion of transmission, indicating light will stay on; and if transmission is not successful, the indicating light will keep flashing.

3. Unplug the memory card and connect the supporting USB kit to the computer for checking data.



Caution

- Recorder will save data once per hour, and could save up to 2 weeks of data. When the space is fully occupied, the records of the earliest 1h will be covered.

- When the data within the memory card is read, it will still be kept in the recorder; but while ID or real time has been set again, the data will be eliminated.

- Calibration of recorder

After the power of temperature recorder is on, put the sensor probe into an environment with stable temperature (such as 0°C ice-water mixture). After the recorder enters into the temperature status, you could press 1# or 2# (for about 5 seconds), then the temperature recorder will enter into the mode of temperature calibration after a "Beep" sound. You could press 1# and 2# to adjust it to the left or right in order to align the pointer with the corresponding temperature scale on paper. After that, you could press 3# to confirm or press it for 5 seconds until a "Beep" sound, then the recorder will exit the mode of temperature calibration and return to the mode of recording.



Caution

- Recorder has already been calibrated before delivery, please do not arbitrarily adjust it except any special condition.

- If the freezer is not in use, please switch the recorder to "0" in order to prevent the built-in battery from over discharge.

and the spare battery should be replaced until the LED green light is on without flashing.

2. After the spare battery is removed, if the LED light continue to flash and the recorder works normally, it means that the main power is normal but the spare battery is low in power, which should be replaced until the LED green light is on without flashing.

- Replacing the record paper

For replacing the recorder paper, refer to the following steps:

1. Find out the "Press Out" button (3#) on the upper left in the front of recorder panel;

2. Press (3#) once and then the recorder pen will be moved from the left of paper;

3. When the recorder pen is moved out of the paper completely, please loosen the central bolt and remove the old paper and then replace with the new one, the time line of which should be aligned with the time slot on the panel (which refers to a small groove on the left side of panel);

4. Tighten the central bolt again and then press 3# once to reset the recorder pen and then start recording temperature;

5. Check that whether the pen could be is usable on such paper, otherwise, you could adjust the pen beam in order to keep the nib contacting with the paper.

(Note: Do not damage the nib and beam. If it is difficult for adjustment, you could remove the beam with screwdriver and then slightly bend it and install it back again, and then repeat the operation above mentioned)

6. In order to keep the records accurate, the precision of pen should be calibrated after paper replacement by means as follow: press the button (3#) until the pen is away from the paper, and then press (3#) again until the pen is back to the paper again. At that time the pen will stay on the outer temperature scale mark of paper (which might not be marked with temperature value, but it would be the scale mark at the outer circle). If the pen will not stay on the site above mentioned, you may use 1# or 2# arrow key to adjust the pen's location within 5 seconds, in order to align the nib with the outer scale mark. If you could not adjust the pen's location within 5 seconds, please repeat Step 6.

- Calibration of recorder

The recorder has already been precisely adjusted before delivery, and will not be affected even it is outage. If it is sure for adjustment, please adjust it as follows:

1. Make the freezer under operation until the operation keeps stable (the temperature curve becomes regular), and the recorder has already recorded temperature curve for at least 2 hours;

2. Put a standard thermo-couple in a bottle with 100ml of 10% glycerite, and then put such bottle and the sensor of recorder into the bin together (the recorder sensor could not contact with any solution);

3. About 4 hours after putting such bottle in the bin and when the temperature of the glycerite is the same as that within the bin, you could compare with the temperature value of the standard thermo-couple and that of the recorder. If they are different, you could adjust the temperature value shown on the recorder by pressing the adjustment button on the left (1#) or right (2#) of the panel in order to make it consistent with the indicating value of thermo-couple.

Note: The pen could be moved in 5 seconds after the button is loosened.



Caution

- Recording pen begins to move after loosening button 5s.

- The recorder has been calibrated before leaving factory. Do not adjust the recorder optionally unless special circumstances.

Temperature recorder with USB interface

Temperature recorder with USB interface could be optionally equipped with Type DW-40L278/278J/278(a)/348/348J/508/508J/508(a)/420F and DW-30L420F to record the change of inner temperature. In order to use the recorder in an accurate and reasonable way, please read the following instructions seriously.

• Understand your temperature recorder

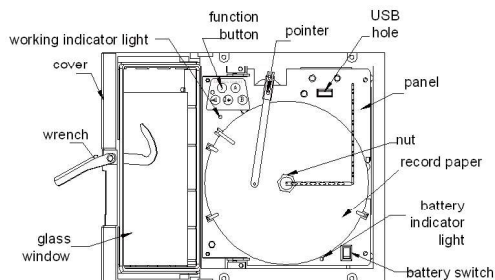

Standard 7-inch paper is adopted for the disc type temperature recorder, and the data could be exported by paper and U disk. Please understand your temperature recorder by referring to the graph above firstly:

1. Top cover and lock latch--relatively protect the temperature recorder. You could open the top cover by slightly lift the latch and pull the cover, and could close the top cover tightly by press the latch after closing the door;
2. Thin film button--it could be used for setting and other basic operation;
 - 1# button: select the temperature range or adjust to left
 - 2# button: select the recording cycle or adjust to right;
 - 3# button: setting button
 - A button: read the data in U disk;
 - B button: time setting;
3. Working indicating light--it will show different colors of light to refer to different ranges of temperature use. For normal use, it will show green light; and when it flashes, it means that the recorder is recording the temperature;
4. Stylus--the nib of stylus could record the data by tightly laying on the paper. The metal pole of stylus is relatively flexible, which could keep the curve clear. The stylus will be covered with a protective cover when delivery, which should be taken when use. It is suggested to keep the protective cover in order to protect the stylus when it would be a long time for no use;
5. USB interface--Matched memory card could be inserted in for setting time and exporting data;
6. Press out the nut and paper--screw and tighten the nut clockwise, and replace the paper by removing the nut;

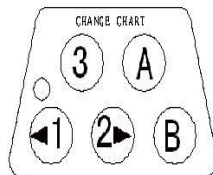

7. Recharge indicating light--When it keeps on, it means that it is under fast charge; when it is flashing, it means that the fast charge is completed, and it is under trickling charge; and when it is off, it means that charge is completed.

8. Button--this switch is the one for rechargeable battery. For normal use, please switch it on, so that the recorder could continue to record temperature for about 24 hours when the battery is fully recharged but external power is cut.

• First use

1. After normal power on, please open the door of recorder and switch the battery to "I" to connect with the back battery;
2. A piece of paper is attached to the recorder. Please check up the paper. If it is needed to replace it, please refer to instructions on P30;
3. In order to protect the recording pen, please cover its nib with the plastic cover, and take it before using it;
4. According to the machine and your demand, please adjust the temperature range of recorder and the recording time cycle. The temperature range shows the range of temperature recorder, while the time cycle refers to the time when the temperature recorder take a full piece of paper of records. After completion of adjustment, the recorder will automatically record current setting position and cycle without repeated adjustment.

• Adjustment of temperature range and cycle

1. After normal power on, press 3# for about 5 seconds, and then the recorder will cease for moving after a sound of "Di" is sent from the recorder, which means that the recorder enters into the setting mode;
2. Press 1# could switch the range. Press once, the color of indicating light below will change once, and different color refers to different position, and the colors and positions could be related as follows:
 - Green: -40°C ~+30°C (applicable to this product, which should be selected)
 - Yellow: -115°C ~+50°C
 - Red: -200°C ~+0°C

Note: The recorder will start working until the inner temperature falls in the recording range based on the temperature range above.

3. Press 2# to select the recording cycle. There is two cycle for choosing, which would be differentiated by the sound made by the machine:

When the cycle is 24 hours: the sound will quick but short;

When the cycle is 7 days: the sound will short but continuous (this is recommended, for paper could be saved)

4. After adjust the range and cycle in place, press 3# once to exit the setting mode.

• Paper calibration

1. After the power is on and the position and cycle have already been set, the equipment should calibrate the paper before validate the setting of position and cycle in order to keep the test accurate. If the position and cycle has not been adjusted 5 seconds after the power is on, the machine will enter into the mode of paper calibration automatically by the means as follows:

After pressing 3# once, the stylus will be moved to the site marked with -40°C and stayed there for 3 seconds, and at this time you could check that whether the pointer aligns with the scale on paper or not. If not, you could tune the pointer by pressing 1# or 2#;